

A Complete Line of Paint Spray Accessories

TITAN

Airless Spray Technology



Accessories



The Industry's Highest Quality Accessories



*Global Leader in Paint
Spray Technology*

New Products



S-3

- Stainless steel fluid passages.
- Tungsten carbide ball valve and seat insures long life and durability.
- Easy 4 finger trigger pull.
- In handle swivel.
- Includes 517 SC-6 reversible tip.
- Pressure rated at 27 MPa (3900 psi).

Product No. 550-250
Repair Kit No. 550-275



S-7

- Stainless steel fluid passages.
- Tungsten carbide ball valve and seat insures long life and durability.
- Easy 4 finger trigger pull.
- In handle swivel.
- Includes 517 heavy-duty reversible tip.
- Pressure rated at 53 MPa (7700 psi).

Product No. 550-260 .63 cm (1/4") Swivel
Product No. 550-270 .95 cm (3/8") Swivel
Repair Kit No. 550-276



LX-70

- All metal construction.
- "In-Line" design is a natural extension to any pole or gun extension.
- Pressure rated at 25 MPa (3600 psi).

Product No. 550-475

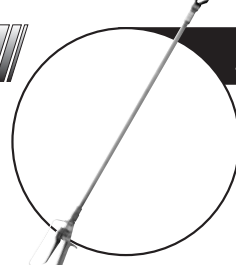

LX-75 4' Pole Gun

- Full length needle ensures positive shut-off at tip.
- Pressure rated at 25 MPa (3600 psi).
- Reach those high, out-of-the-way places that normally require the use of a ladder or scaffolding.

Product No. 550-495 122 cm (4')

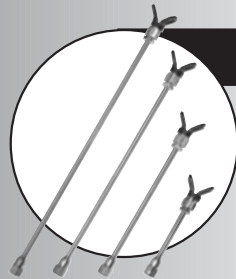

Gun Extensions

Aluminum

- Lightweight and easy to handle.
- Can be used with most brands of airless spray guns.
- Pressure rated at 25 MPa (3600 psi).

<u>22.23 mm (7/8") Thread - Standard</u>	<u>17.46 mm (11/16") Thread</u>
15 cm (6") Product No. 651-070	15 cm (6") Product No. 651-121
30 cm (12") Product No. 651-071	30 cm (12") Product No. 651-122
45 cm (18") Product No. 651-072	45 cm (18") Product No. 651-123
60 cm (24") Product No. 651-073	60 cm (24") Product No. 651-124

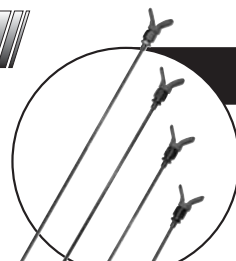

Gun Extensions

Stainless Steel

- Heavy duty stainless steel.
- Can be used with most brands of airless spray guns.
- Pressure rated at 53 MPa (7700 psi).

<u>22.23 mm (7/8") Thread - Standard</u>
15 cm (6") Product No. 611-280
30 cm (12") Product No. 611-281
45 cm (18") Product No. 611-282
60 cm (24") Product No. 611-283

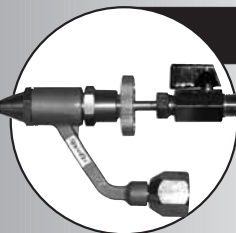

Splatter Nozzle

- Fully adjustable.
- Designed to spray joint compound.
- Perfect for knockdown applications and splatter effect.
- Includes 3 mix nozzles and 2 air nozzles.

Product No. 765-360



Tip Clean

- Hour-glass design allows easy cleaning of all airless tips and safe storage.
- Cleaning fluid removes contamination and paint residue, ensuring best spraying results.

Product No. 314-207 (200ml / 7 ozs.)

Table of Contents

Airless Guns and Hose Reels

LX-80", LX-80 Platinum, Gun, Tip and Hose Kits, S-5, LX-70 In-Line Gun, 6' Outrigger, Reel EZ Hose Reels

pgs. 1-2

Tips

SC-6 Reversible Tip, WIDESPAY Tip, SYNERGY™ Tip, Seals, SC-6 Guard

pg. 3

Airless Tips and Bases

Stainless Steel Tip and Guard, Adjustable Self Cleaning Tip, Airless Spray Tip Recommendation Chart

pg. 4

Understanding Airless Tips

Understanding Airless Tips, Tip Wear, Understanding Tip Product Numbers

pgs. 5-6

Modules, Metering Orifices and Flat Tips

Control Modules, Fine Finish Metering Orifice, Tungsten Carbide Flat Tips

pg. 7

SideStriper

SideStriper

pg. 8

PowrLiner Accessories

Portable Headlight, Paint Hopper, Laser Pointer, Second Gun Kit, Floating Gun Kit, SC-6 Line Striping Tip, Striping Tip Comparison, Stencil Kit

pgs. 9-10

Gun Extensions and Poles

Airless Gun Extensions - Aluminum, Extension Pole, Gun Extension Swivel Head, Angle Adapter Assembly, Extension Pole Coupling

pgs. 11-12

Roller Assemblies

Inner Feed Pressure Roller, Spray Roller, Telescoping Pressure Roller, Inner Feed Pressure Roller Kit, Spray Roller Kit, 3-In-1 Spray/Roll Application Kit, Roller Head Replacement Covers

pgs. 13-14

Hoses and Whips

High Quality Airless Hose, Airless Fluid Hose Whips

pg. 15

ConvertoKits, Gauge Kit and Swivels

ConvertoKits, High Pressure Fluid Gauge Kit, High Pressure Swivels

pg. 16

Fittings

90° Street Elbows, Reducer Bushings, Hose To Hose Couplings, Pipe Tees, Manifold To Manifold Couplings, Swivel Union, Manifold To Hose Couplings, Pipe Plugs

pg. 17

Filters, Packing Kits and Lubricants

Pump Manifold Filters, Piston Lube, Alrcare, Coolflo, Grease, Repacking Kit Chart, LS-10 Liquid Shield Plus

pg. 18

Filters and Inlet Screens

In-Line Filter, Gun and Pump Filters, Inlet Screens

pg. 19

Modular Gun Manifold

Gun Manifold Assemblies, Gun Add On Kits

pg. 20

Pro-Finish Gun and Accessories

Pro-Finish HVLP Gun, Pro-Finish Needle/Nozzle Set, Pro-Finish Air Cap, Pro-Finish Atomizing Kit, Pro-Finish Needle/Nozzle and Air Cap Recommendation Chart, Pro-Finish Air Hose, .95 L (Quart) Cup, 9.5 L (2.5 Gal) Disposable Liner, Siphon Filters, Regulator Complete, .95 L (Quart) Cup Lid One-Way Valve, .95 L (Quart) Cup Strainer, 61 cm (2 Ft.) Flexible Whip, .95 L (Quart) Cup Lid Gaskets, Pro-Finish Fluid Hose, Quick Disconnect, TSP System, Fluid Hose Connector, Turbine Replacement Filters

pgs. 21-24

Airless Guns

Airless Guns, Hose Reels



LX-80'

- Available with 4 finger trigger or adjustable 2 finger trigger.
- All metal construction.
- Tungsten carbide ball valve, seat and stainless steel swivel insures long life and durability.
- In-handle filter reduces clogging and increases tip life.
- Swivel reduces hose kinks and assures effortless control.
- Includes 517 SC-6 reversible tip.
- Lightweight, only 0.63 kg (20 oz).
- Pressure rated at 25 MPa (3600 psi).

Product No. 580-100A (4 Finger Trigger)
 Product No. 581-085 (2 Finger Trigger)
 Repair Kit No. 580-034A
 Replacement Filters No. 500-200-XX

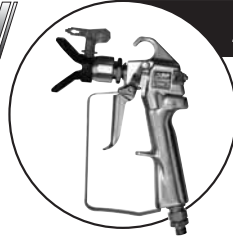

LX-80 Platinum

- All metal construction.
- Reversible tungsten carbide seat offers twice the life of standard diffusers.
- Unique two-piece seal assembly design allows removal of just the ball for easy maintenance.
- Ultra-light trigger pull and form fitting handle reduces hand fatigue.
- Swivel reduces hose kinks.
- In-handle filter helps reduce tip clogs and increase tip life.
- Includes 517 SC-6 reversible tip.
- Pressure rated at 25 MPa (3600 psi).

Product No. 584-100
 Repair Kit No. 594-040
 (Ball and Seat Gasket Only)
 Repair Kit No. 584-045 (Complete Kit)
 Replacement Filters No. 500-200-XX



Reel EZ Hose Reels

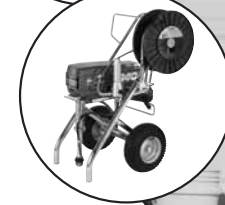

- The Reel-EZ virtually eliminates hose hassles and increases your production. The Reel-EZ 16 mounts to the frame of all Titan and Speeflo cart style paint sprayers with a heavy duty universal mounting bracket. The Reel-EZ 10 mounts to the frame of all Titan skid style paint sprayers such as the 440i. Both the Reel-EZ 16 and Reel-EZ 10 mount to most major manufacturer's paint sprayers with similar designs.
- The Reel-EZ 16 can hold up to 30.5 m (100') of 6.35 mm (1/4") airless hose and the Reel-EZ 10 can hold up to 15.2 m (50') of 6.35 mm (1/4") airless hose. Both are rated at 25 MPa (3600 psi).

Reel-EZ 16 Cart-Mount
 Product No. 769-100

Reel-EZ 10 Skid-Mount
 Product No. 769-200

Gun, Tip and Hose Kits



S-3 GTH Kit Shown

Includes airless gun with 517 SC-6 reversible tip and 15m x 6mm (50" x 1/4") high quality airless hose with spring guards.

LX-80 Platinum Gun, Tip and Hose Kit
 Product No. 584-050
 LX-80II Gun, Tip and Hose Kit
 Product No. (4 Finger Trigger) 580-050
 (2 Finger Trigger) 581-150

S-3 Gun, Tip and Hose Kit
 Product No. 550-460
 S-5 Gun, Tip and Hose Kit
 Product No. 550-110

S-5



- All metal construction.
- Stainless steel fluid passages.
- Tungsten carbide ball valve and seat insures long life and durability.
- Easy 2 finger trigger pull.
- Includes 517 SC-6 reversible tip.
- Pressure rated at 34.5 MPa (5000 psi).

Product No. 550-100
 Repair Kit No. 520-025

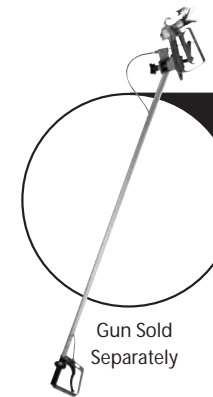

Gun Sold Separately

6' Outrigger

- Convert existing gun to 2 m (6') pole gun and back in seconds.
- Allows you to increase production and profits.
- Constructed of lightweight and rigid aluminum to reduce arm fatigue.
- Large, gun installation holder and knob.
- No additional hoses or fittings required.
- Adapts to all Titan airless spray guns and most manufacturers airless spray guns.

Product No. 757-920

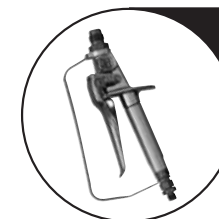

LX-70 In-Line Gun

- All metal construction.
- In-handle filter.
- Swivel reduces hose kinks and ensures effortless control.
- Pressure rate at 25 MPa (3600 psi).

Product No. 550-475
 Repair Kit No. 550-487

Tips, Seals, SC-6 Guard

Airless Tips, Bases

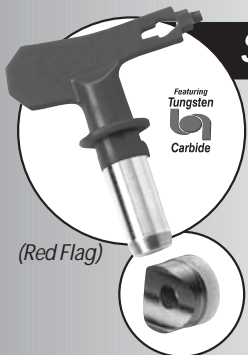

SC-6 Reversible Tip

"Longest Lasting Tip In The Industry"

- Ergonomic design ensures comfort.
- Exclusive flow indicator.
- Highest quality tungsten carbide assures longest life and durability.
- Insertion and knockout tool for no fuss assembly.
- Interchangeable with most competitive bases.

Product No. 661-XXX

		SC-6 Tip Chart															
		Orifice Size (mm)															
		.18	.23	.28	.33	.38	.43	.48	.53	.58	.63	.68	.73	.78	.83	.88	.93
Fan Width (mm)	51-102	.107	.109	.111	.113	.115	.117										
	102-152	.207	.209	.211	.213	.215	.217	.219	.221	.223	.225						
	152-203	.307	.309	.311	.313	.315	.317	.319	.321	.323	.325						
	203-254	.407	.409	.411	.413	.415	.417	.419	.421	.423	.425	.427			.431	.435	
	254-305		.509	.511	.513	.515	.517	.519	.521	.523	.525	.527	.529	.531	.533	.535	.539
	305-356		.609	.611	.613	.615	.617	.619	.621	.623	.625	.627	.629	.631	.633	.635	
	356-406			.715	.717	.719	.721	.723	.725						.731	.735	
	406-457				.815	.817	.819	.821	.823						.831	.835	
	457-508							.919	.921								

*Please call for additional sizes



WIDESPRA Y Reversible Wide Angle Tip

- Designed for high production applications.
- Increase production up to 100%.
- Widespray will save you time and money.

Product No. 661-XXXX

WIDESPRA Y™ Reversible Wide Angle Tip Chart

Tip Part Number (661-XXXX)					
1219	1221	1223	1225	1227	
1229	1231	1233	1235	1237	



SYNERGY™ Fine Finish Reversible Tip

- Ideal for lacquers, Stain, Urethane and clear top coats.
- Features up to 27% finer atomization at lower pressures.
- Increases transfer efficiency.

Product No. 671-XXXX

SYNERGY™ Fine Finish Reversible Tip Chart

Tip Part Number (671-XXXX)				
208	210	212	214	
308	310	312	314	
408	410	412	414	
		512	514	
		612		

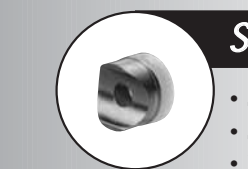

Seals

- Solvent resistant white seal...**651-020**
- Solvent resistant white seal, 6 pack...**661-021**
- Metal seal...**651-040**
- Solvent resistant seal and retainer kit, 5 pieces...**661-020**
- Latex black seal...**651-042**



SC-6 Guard

- Design allows guard to be installed without tools.
- Seal cavity on safety guard has large "flats" for quick and easy installation of seal.
- For use with Titan SC-6 tip only.
- Interchangeable with most competitive bases.

Product No. 661-012

SC-6 Safety Guard Specification Chart

661-012	22.23 mm (7/8")	SC-6 Guard Titan, Wagner, Graco, Spray TECH, ASM
661-015	17.46 mm (11/16")	SC-6 Guard #3 Speeflo, ASM, Spray TECH, Taiver
661-016	19.05 mm (3/4")	SC-6 Guard #8 (Binks)

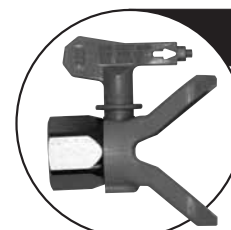

High Pressure Stainless Steel Tip and Guard

- Heavy duty reversible tip.
- Pressure rated at 53 MPa (7700 psi).

Guard Product Numbers

- 661-027 — 22.23 mm (7/8") thread
- 661-028 — 17.46 mm (11/16") thread

Stainless Steel Tip Chart

Tip Part Number (721-XXX)					
117	217	225	523	531	821
119	219	517	525	533	831
121	221	519	527	535	835
123	223	521	529	539	



Adjustable Self Cleaning Tip

Operator-selected fan sizes and complete control of the orifice opening give the Adjustable Tip versatility. Because the orifice size can be fingertip controlled, clogged particles are cleared instantly, without triggering. Adjustable Tips are engineered to perform multiple airless applications efficiently and quickly, reducing overspray and downtime. Pressure rated at 24.3 MPa (3500 psi).

- Fully adjustable fan widths from 51 mm to 610 mm (2" to 24") reduce overspray.
- Self-cleaning feature eliminates costly downtime due to clogs.
- Tungsten Carbide wear parts for long life.
- Lightweight - less than one ounce.

Safety Guard Specification Chart

450-100A	22.23 mm (7/8")-14	Titan, Wagner, Graco, Spray TECH, ASM
450-300	17.46 mm (11/16")-16	Speeflo, H-Gun, ASM, Taiver

Material To Be Sprayed	Product Number	Orifice Range	Fan Width
Lacquer and Stain	341-015	.005-.018	5-36 cm (2-14 in.)
Lacquer and Stain	341-020	.007-.019	10-51 cm (4-20 in.)
Latex and Enamel	341-024	.007-.026	5-36 cm (2-14 in.)
Latex and Enamel	341-028	.011-.026	15-60 cm (6-22 in.)
High Builds	341-041	.017-.035	15-60 cm (6-22 in.)
Very Heavy	341-049	.021-.054	15-41 cm (6-16 in.)

To order carbide replacement pins, replace the zero (0) in the tip part number with a three (3). Example: 341-028 replacement pin part number is 341-328.

Product No. 341-XXX

- Fits most popular guns without an adapter.
- Available in six different sizes to suit most materials and job conditions. (Refer to selection chart)
- 3.18 mm (.125") gasket included.
- Order 450 series guard for use with Adjustable Tips. (Refer to Safety Guard Specification Chart)

Airless Spray Tip Recommendation Chart

Coating	Viscosity	Filter Mesh	Orifice Range	Synergy™ (Fine-Finish)
Varnishes	Light	100-150	.009-.011	.008-.010
Lacquer Finishes (clear)			.009-.011	.008-.010
Sanding Sealers			.009-.011	.008-.010
Shellac (clear)			.009-.013	.008-.012
Transparent Stain			.011-.013	.010-.012
Water Sealers (clear)			.011-.013	.010-.012
Solid Stains	Medium	60-100	.013-.015	
Exterior House Paints			.013-.017	
Interior Wall Paints			.013-.017	
Interior and Exterior Primers			.017-.019	
Commercial Grade	Heavy	30-60		
Architectural Coatings			.017-.019	
Interior Wall Paints			.017-.019	
Interior Wall Primers			.017-.019	
Dry Fall (quick dry)			.019-.023	
One Coat, Primer-Finish Paints			.019-.023	
Elastomerics	Extra Heavy	Remove	.021-.031	
Pigmented Waterproofers			.021-.027	
Block Filler			.025-.031	

Orifice sizes recommended on this chart are based on fan widths between 20 cm (8 inches) and 30 cm (12 inches).

Understanding Airless Tips

Understanding Airless Tips

Understanding Airless Tips

Airless spray tips are a key component to the successful operation of an airless spray system. They define the spray pattern, control the flow of the coating being sprayed and ultimately tell the pump how hard it must work. A proper understanding of airless tips is critical to the success of any airless application.

Airless Spray Tip Characteristics

It is important to remember that the orifice size, in conjunction with the fan-width size, determines the spray characteristics of the tip.

Examples: The larger the orifice with the same fan width, the greater the volume of paint applied to the same area.

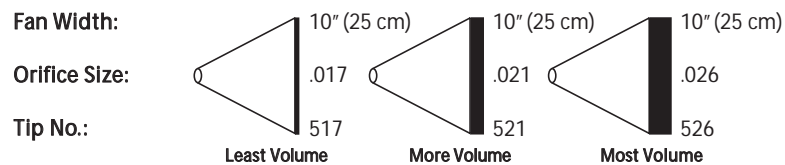

Conversely, the larger the fan width with the same orifice means the same amount of material is being applied over a greater area. The result is less volume of paint per square inch.

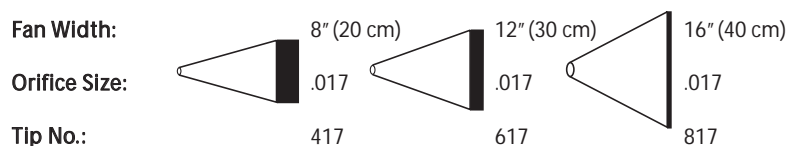

Tip Wear

When beginning a project, choosing the right tip size and fan width will determine how profitable you will be through both coating consumption and production time. If the tip size being used is wrong — by either choice or through wear — mil thicknesses will be too heavy and the finish will be unprofessional.

The spray pattern chart demonstrates what happens as a tip wears. As wear occurs, the pattern size decreases and the orifice size increases. You will find that you have to make more passes to cover the same area. There is no standard rate of tip wear due to the variation of the abrasiveness of all coatings. Replace your tips after 378 liters (100 gallons); it's one of the most profitable things you can do.

Spray Pattern Width			
(25-30 cm)	(20 cm)	(15 cm)	(10 cm)
10"-12"	8"	6"	4"
Tip Size			
New	Worn to	Worn to	Worn to
517	419	321	223
Flow Rate			
(1.1 lpm)	(1.5 lpm)	(1.7 lpm)	(2.1 lpm)
.30 gpm	.40 gpm	.47 gpm	.57 gpm
Flow Rate Increase			
	33%	57%	90%

Understanding Tip Product Numbers

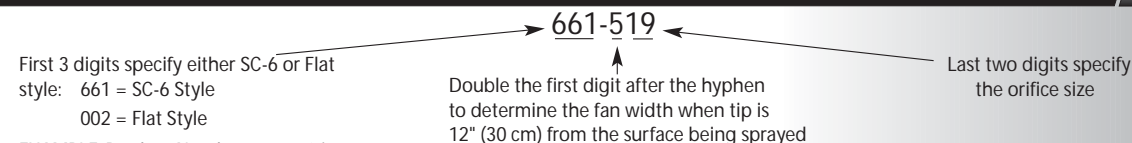

EXAMPLE: Product Number 661-519 is:
 • SC-6 Reversible Tip • 10"-12" (25-30 cm) Fan Pattern • .019 orifice

When ordering airless spray tips from this chart, precede the tip number with "661" for SC-6 and "002" for Flat.

Orifice Size In Inches	Fan Width In Inches	GPM Flow Rate	Flat and SC-6 Tip Number*	Orifice Size In Inches	Fan Width In Inches	GPM Flow Rate	Flat and SC-6 Tip Number*	Orifice Size In Inches	Fan Width In Inches	GPM Flow Rate	Flat and SC-6 Tip Number*
.007	2"-4"	.05	107	.019	4"-6"	.40	219	.031	6"-8"	1.1	331
	4"-6"	(.2 lpm)	207		6"-8"	(1.5 lpm)	319		8"-10"	(4.1 lpm)	431
	6"-8"		307		8"-10"		419		10"-12"		531
	8"-10"		407		10"-12"		519		12"-14"		631
.009	2"-4"	.08	109		12"-14"		619		14"-16"		731
	4"-6"	(.3 lpm)	209		14"-16"		719		16"-18"		831
	6"-8"		309		16"-18"		819		18"-20"		931
	8"-10"		409		18"-20"		919	.033	10"-12"	1.2	533
	10"-12"		509	.021	4"-6"	.47	221	(.084 cm)	12"-14"	(4.5 lpm)	633
	12"-14"		609		6"-8"	(1.7 lpm)	321	.035	6"-8"	1.3	335
.011	2"-4"	.12	111		8"-10"		421	(.089 cm)	8"-10"	(4.9 lpm)	435
	4"-6"	(.5 lpm)	211		10"-12"		521		10"-12"		535
	6"-8"		311		12"-14"		621		12"-14"		635
	8"-10"		411		14"-16"		721		14"-16"		735
	10"-12"		511		16"-18"		821		16"-18"		835
	12"-14"		611		18"-20"		921	.039	8"-10"	1.65	439
	14"-16"		711		20"-22"		1021	(.099 cm)	10"-12"	(6.2 lpm)	539
	16"-18"		811	.023	4"-6"	.57	223		12"-14"		639
	18"-20"		911	(.058 cm)	6"-8"	(2.1 lpm)	323		16"-18"		839
.013	2"-4"	.18	113		8"-10"		423	.043	8"-10"	2.05	443
	4"-6"	(.7 lpm)	213		10"-12"		523	(.109 cm)	10"-12"	(7.8 lpm)	543
	6"-8"		313		12"-14"		623		22"-24"		1143
	8"-10"		413		14"-16"		723	The following sizes are available in Flat Tip Only:			
	10"-12"		513		16"-18"		823	.052	10"-12"	3.0	552
	12"-14"		613		18"-20"		923	(.132 cm)	22"-24"	(11.3 lpm)	1152
	14"-16"		713		20"-22"		1023	.062	10"-12"	4.25	562
	16"-18"		813	.025	4"-6"	.66	225	(.157 cm)		(16 lpm)	
	18"-20"		913	(.064 cm)	6"-8"	(2.5 lpm)	325	.072	10"-12"	5.75	572
.015	2"-4"	.23	115		8"-10"		425	(.182 cm)		(22 lpm)	
	4"-6"	(.9 lpm)	215		10"-12"		525	Spray width measured with gun tip 12 inches (30 cm) from work surface. Other sizes available, call 800-526-5362 for more information.			
	6"-8"		315		12"-14"		625	*Sizes Available as a flat tip only are bold and italicized.			
	8"-10"		415		14"-16"		725				
	10"-12"		515		16"-18"		825				
	12"-14"		615		18"-20"		925				
	14"-16"		715	.027	6"-8"	.77	327				
	16"-18"		815	(.069 cm)	8"-10"	(2.9 lpm)	427				
	18"-20"		915		10"-12"		527				
.017	2"-4"	.30	117		12"-14"		627				
	4"-6"	(1.1 lpm)	217		14"-16"		727				
	6"-8"		317		16"-18"		827				
	8"-10"		417		18"-20"		927				
	10"-12"		517	.029	10"-12"	.88	529				
	12"-14"		617	(.074 cm)	12"-14"	(3.3 lpm)	629				
	14"-16"		717								
	16"-18"		817								
	18"-20"		917								

Modules, Metering Orifices, Flat Tips

SideStriper

Control Modules

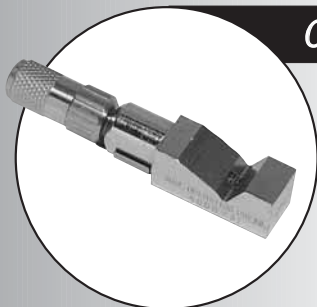

• For use with the 550-SC Telescoping Pole Gun.

Material To Be Sprayed	Product Number	Orifice Range	Fan Width
Lacquer and Stain	500-015M	.127-.457 mm (.005-.018")	5-36 cm (2-14")
Lacquer and Stain	500-020M	.178-.483 mm (.007-.019")	10-51 cm (4-20")
Latex and Enamel	500-024M	.178-.660 mm (.007-.026")	5-36 cm (2-14")
Latex and Enamel	500-028M	.279-.660 mm (.011-.026")	15-61 cm (6-24")
High Builds	500-041M	.432-.889 mm (.017-.035")	15-61 cm (6-24")
Very Heavy	500-049M	.533-1.37 mm (.021-.054")	15-41 cm (6-16")

Fine Finish Metering Orifice

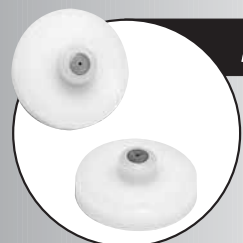

- Make your Flat Tip and Adjustable Tip a Fine Finish Tip.
- Increases your transfer efficiency by allowing you to spray at lower pressures.
- Designed to produce a more complete atomization of the spray pattern.
- Fits the inlets of most tungsten carbide (flat) spray tips and adjustable tips.
- Constructed of the highest quality tungsten carbide.
- Serves as a gasket to assure a high pressure seal between the spray tip and gun.
- When ordering, always use a metering orifice that is at least .004 larger than the spray tip being used. Example: a .019 tip should be used with a .023 Metering Orifice.
- For use with 450 Series guards, refer to Safety Guard Specification Chart below.

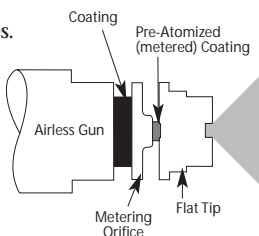

Product Number	Orifice In Inches	Max. Corresponding Tip Size Recommended
512-011	.011	.007
512-013	.013	.009
512-015	.015	.011
512-018	.018	.013
512-021	.021	.017
512-023	.023	.019
512-026	.026	.021
512-031	.031	.026
512-035	.035	.031
512-039	.039	.035
512-043	.043	.039
512-049	.049	.043
512-059	.059	.052

Tungsten Carbide Flat Tips



- Precision machined from the highest quality Tungsten Carbide.
- Available in sizes from .007- .072.
- Gasket not included.
- See page 6 for available sizes.

Order 450 series guards for use with flat tips.
Product No. 002-XXX

711-612A 3.18 mm (1/8") Gasket Kit (12)
 711-606 1.59 mm (1/16") Gasket Kit (12)



Safety Guard Specification Chart		
450-100A	22.23 mm (7/8")-14	Titan, Wagner, Graco, Spray TECH, ASM
450-300	17.46 mm (11/16")-16	Speeflo, H-Gun, ASM, Taiver

SideStriper

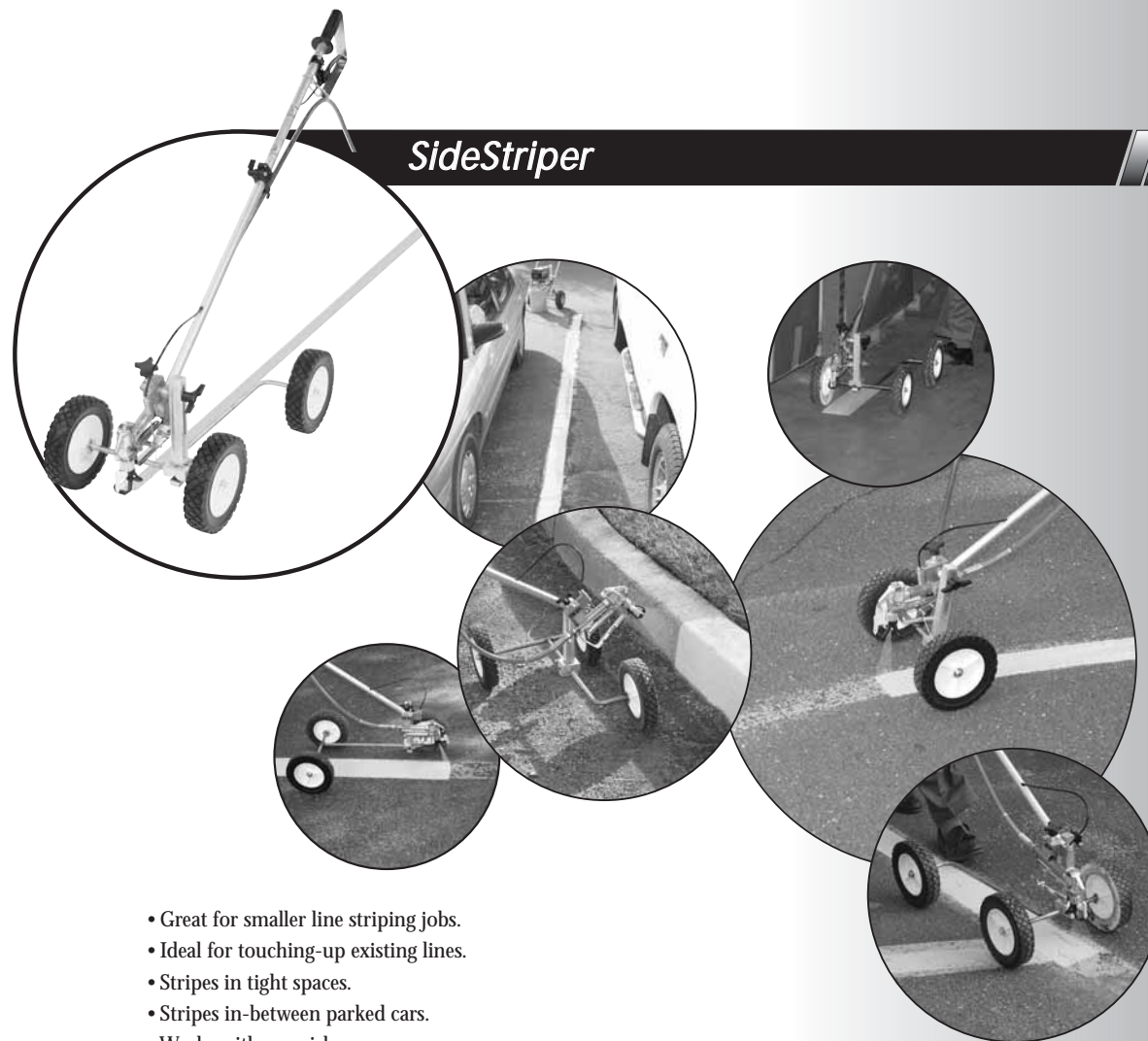

- Great for smaller line striping jobs.
- Ideal for touching-up existing lines.
- Stripes in tight spaces.
- Stripes in-between parked cars.
- Works with any airless sprayer.
- Simple striping instructions.
- Compact, lightweight and portable.
- Easy-to-use.
- Ideal applications include: parking lots, in-between cars, curbs, radius and warehouses.
- Kit includes: (1) Metal Pole, (3) Wheels, (1) SC-6 Striping Tip, (1) Parts Kit and (1) Striping Instructions.

Product No. 759-150

PowrLiner Accessories

PowrLiner Accessories



Portable Headlight

Portable headlight lights the job so work can continue at night for higher profits.

Part No. 759-145



Paint Hopper

Holds up to 45 L (12 gal) of paint.

Part No. 759-130



Laser Pointer

Laser Pointer for perfect starts and easy line tracking.

Part No. 759-140



Second Gun Kit

Second Gun Kit - Complete with gun for wide or dual lines. Mounts on either side of striper.

Part No. 759-038



Floating Gun Kit

SureTrak™ Floating Gun Mount keeps the gun at the proper height from the surface for perfect lines over rough terrain.

Part No. 759-120



(Yellow Flag)

SC-6 Line Striping Tip

Designed specifically for line striping applications such as parking lot lines, road lines, athletic field markings, etc. These striping tips create sharp edges for cleaner, more distinct lines that last longer.

Designed to last longer than standard airless tips, Titan's striping tips are precision machined from high quality Tungsten Carbide and are compatible with all striping coatings.

Popular Applications	SC-6 Product No.	Flat Product No.
Parking lot lines 10-15 cm (4" - 6")	665-1708 or 1908	018-1704 or 1904
Long lines 10-15 cm (4" - 6")	665-2308	018-2304
Athletic lines 5 cm (2")	665-1504	018-1502

Other sizes and fan widths are available. See your dealer or call 1-800-526-5362 for details.

- Solvent resistant seal...651-020
- Metal seal...651-040
- Solvent resistant seal and retainer kit, 5 pieces...661-020



Part No.	Line Width	Guard Description
661-012	22.23 mm (7/8")-14	SC-6 Guard Titan, Wagner, Graco, Spray TECH, ASM
661-015	17.46 mm (11/16")-16	SC-6 Guard #3 Speeflo, ASM, Spray TECH, Taiver
661-016	19.05 mm (3/4")-20	SC-6 Guard #8 (Binks)

Striping Tip Comparison

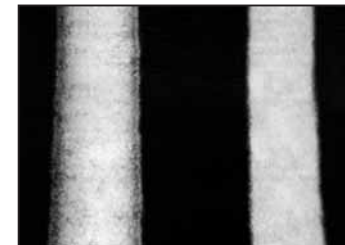

Standard Airless Tips SC-6 Striping Tip

Tip Part No.	Line Width	Orifice Size
665-1302	25-51 mm (1"-2")	.33 mm (.013")
665-1304	51-102 mm (2"-4")	.33 mm (.013")
665-1308	102-152 mm (4"-6")	.33 mm (.013")
665-1502	25-51 mm (1"-2")	.38 mm (.015")
665-1504	51-102 mm (2"-4")	.38 mm (.015")
665-1508	102-152 mm (4"-6")	.38 mm (.015")
665-1512	152-203 mm (6"-8")	.38 mm (.015")
665-1702	25-51 mm (1"-2")	.43 mm (.017")
665-1704	51-102 mm (2"-4")	.43 mm (.017")
665-1708	102-152 mm (4"-6")	.43 mm (.017")
665-1904	51-102 mm (2"-4")	.48 mm (.019")
665-1908	102-152 mm (4"-6")	.48 mm (.019")
665-2108	102-152 mm (4"-6")	.53 mm (.021")
665-2112	152-203 mm (6"-8")	.53 mm (.021")
665-2308	102-152 mm (4"-6")	.58 mm (.023")
665-2312	152-203 mm (6"-8")	.58 mm (.023")
665-2508	102-152 mm (4"-6")	.64 mm (.025")
665-2512	152-203 mm (6"-8")	.64 mm (.025")
665-2708	102-152 mm (4"-6")	.69 mm (.027")
665-2712	152-203 mm (6"-8")	.69 mm (.027")
665-2908	102-152 mm (4"-6")	.74 mm (.029")
665-2912	152-203 mm (6"-8")	.74 mm (.029")
665-3108	102-152 mm (4"-6")	.79 mm (.031")
665-3112	152-203 mm (6"-8")	.79 mm (.031")
665-3508	102-152 mm (4"-6")	.89 mm (.035")
665-3512	152-203 mm (6"-8")	.89 mm (.035")
665-3908	102-152 mm (4"-6")	.99 mm (.039")
665-3912	152-203 mm (6"-8")	.99 mm (.039")
665-4308	102-152 mm (4"-6")	1.09 mm (.043")
665-4312	152-203 mm (6"-8")	1.09 mm (.043")



Stencil Kit

Stencils are molded of .15 cm (1/16") durolast polyethylene. This material is very durable and lays flat on surface being stenciled for clean and accurate marking.

- Kit contains one each of the following:
- 55 cm (21 1/2") Handicap
 - 105 cm (42") Straight Arrow
 - 105 cm (42") Curved Arrow
 - 30 cm (12") No Parking
 - 30 cm (12") Fire Lane
 - 30 cm (12") Number Kit (0-9)
 - 10 cm (4") No Parking
 - 10 cm (4") Fire Lane
 - 10 cm (4") Visitors
 - 10 cm (4") Reserved

Product No. 756-135

Extensions, Swivel Head

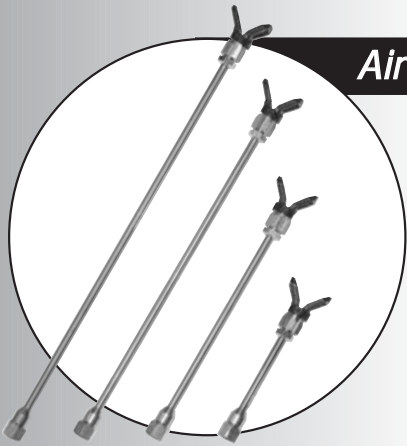

Airless Gun Extensions - Aluminum

- Lightweight and easy to handle, Titan Gun Extensions provide extra reach which keeps the operator and equipment cleaner.
- Available in lengths from 15-60 cm (6" to 24").
- Can be used with most brands of airless spray guns.
- Guard available in 661 Series only for use with SC-6 Reversible tips.
- Pressure rated to 34.5 MPa (3600 psi).

22.23 mm (7/8") Thread - Standard		17.46 mm (11/16") Thread	
15 cm (6")	Product No. 651-070	15 cm (6")	Product No. 651-121
30 cm (12")	Product No. 651-071	30 cm (12")	Product No. 651-122
45 cm (18")	Product No. 651-072	45 cm (18")	Product No. 651-123
60 cm (24")	Product No. 651-073	60 cm (24")	Product No. 651-124

Extension Pole

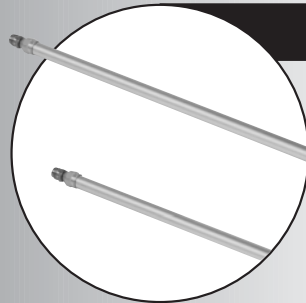

These lightweight aluminum extensions are constructed with inner core ribs which reinforce the pole and greatly increase their rigidity. The inner core rib construction allows different length poles to be easily coupled together up to 3.66 m (12'), while maintaining the proper rigidity to suit most job conditions.

- Reach high out-of-the-way places when spray or pressure rolling.
- Adapts to most airless guns.
- Includes 310-062 extension pole coupling.
- Pressure rated at 25 MPa (3600 psi).

(Refer to the retaining nut chart on this page to select the proper nut size to adapt to your Airless Gun. Always use #1 nut when using Titan Angle Adapter.)

45 cm (1.5') Pole	Product No. 310-381-X
90 cm (3') Pole	Product No. 310-383-X
180 cm (6') Pole	Product No. 310-386-X

(Replace "X" with corresponding number from retaining nut chart)

Retaining Nut Specification Chart		Retaining Nut Only
Size No.	Manufacturer	
1	Titan, Graco, Wagner, Spray TECH, ASM	611-652
3	ASM, Spray TECH, Taiver, Speeflo Pole Mount Nut 711-010	611-653

90 cm (3') Extension Pole with Swivel Head, 22.23 mm (7/8")_Nut	Product No. 310-390
180 cm (6') Extension Pole with Swivel Head, 22.23 mm (7/8")_Nut	Product No. 310-391

Adapter, Pole Coupling



Gun Extension Swivel Head

Permits a 260° rotation for greater spraying versatility and accessibility. For use with Titan Gun Extensions and Extension Poles.

22.23 mm (7/8") Thread - Standard
Product No. 651-139

17.46 mm (11/16") Thread
Product No. 651-140

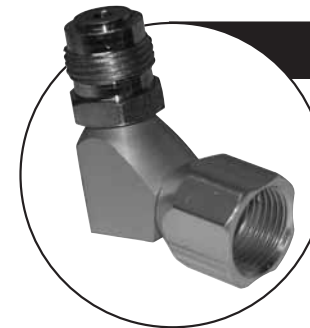

Angle Adapter Assembly

Adapt any extension pole to any standard airless gun. Because of its right-angle design, the angle adapter allows the pole to extend from the gun at the same angle as the handle. The result is greater efficiency and comfort. Pressure rated at 25 MPa (3600 psi).

Refer to the retaining nut chart on this page to select the proper nut size to adapt to your airless gun.

Product No. 310-072-X

(Replace "X" with corresponding number from retaining nut chart)

Retaining Nut Specification Chart

Size No.	Manufacturer
1	Titan, Graco, Wagner, Spray TECH, ASM
3	ASM, Spray TECH, Taiver, Speeflo

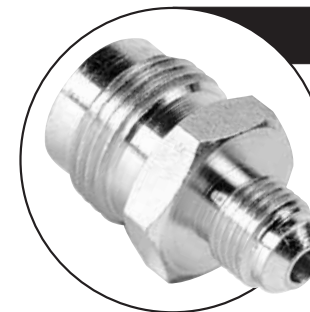

Extension Pole Coupling

Allows you to connect different length extruded poles together to create different lengths for any application. Do not exceed 3.66 m (12').

Product No. 310-062

Roller Assemblies

Inner Feed Pressure Roller



The Inner Feed Pressure Roller is specifically designed for the professional concerned with high production paint applications. The paint distributor mechanism is actually an auger which rotates through the length of the head assembly to evenly distribute paint to all points of the roller cover. It is this device that allows the operator to spend more time applying paint without concern for heavy build-ups or uneven paint distribution.

- For high production paint applications where spraying is impractical.
- Lightweight, strong and designed for comfort, the Inner Feed Pressure Roller incorporates a rigid pole and a unique paint distributor mechanism.
- Best when used with Titan 310 Series Extruded Poles and L-50 In-Line Gun.
- Comes packaged with 1.3 cm (1/2") nap roller cover. See the full line accessory brochure for a complete listing of various sizes.

22.86 cm (9") Roller Head
Product No. 310-934

Inner Feed Repair Kit
Product No. 310-905

Spray Roller



The Spray Roller is a one man, one motion unit, combining the advantages of airless spraying and the ease of a roller. The material is sprayed directly on to the surface without going through or on the roller. Therefore, the materials can be applied quickly, evenly and completely.

- Uses standard 228 mm (9") roller covers.
- Capable of applying block fillers and other heavy materials.
- Applications which require spraying and back-rolling can now be accomplished by one person, in one motion.
- The roller finish allows quick and easy touch-up.
- Back-rolling the surface means you can reduce fluid pressure, further reducing overspray.
- Pole extensions can be coupled together to vary length up to 3.66 m (12').
- The spray roller comes equipped with SC-6 airless reversible tip and easily converts to an airless pole extension for spraying purposes.

22.86 cm (9") Spray Roller Head Assembly Product No. 310-049

Telescoping Pressure Roller (Low Pressure)



- For high production paint applications where spraying is impractical.
- Patented auger head design evenly distributes coating for a professional finish every time.
- Comes with light weight aluminum adjustable pole with a working pressure of 8.3 MPa (1200 psi).
- The exclusive telescoping roller design has a large collar that allows you to quickly adjust the length of the pole from .9 m - 1.8 m (3'-6').
- Also includes Titan's LX-70 In-Line Gun which features an all metal design and a filter in the handle for a superior finish and extended life.

Telescoping Pole Only Product No. 310-938
LX-70 Telescoping Roller Kit with 22.8 cm (9") roller head 1.3 cm (1/2") nap
Product No. 310-950

(Caution! Do not use for spray applications.)

Roller Assemblies

Inner Feed Pressure Roller Kit



- Includes:
- .91 m (3') Pole.
 - 90° Angle Adapter.
 - Inner Feed Roller Head Assembly.
 - 12.7 mm (1/2") x 22.86 cm (9") High Quality Inner Feed Roller Cover.
 - Fits Onto Any Airless Gun.

Product No. 310-150

Spray Roller Kit



- Includes:
- .91 m (3') Pole.
 - 90° Angle Adapter.
 - Spray Roller Head Assembly.
 - 12.7 mm (1/2") x 22.86 cm (9") High Quality Standard Roller Cover.
 - SC-6 Reversible Airless Tip.
 - Fits Onto Any Airless Gun.

Product No. 310-160

3-in-1 Spray/Roll Application Kit



The Spray/Roll Application Kit offers the proper airless spray painting tools for just about every possible painting condition. It's the first complete application kit created for professionals. By selecting the proper combination of tools, the professional painter can choose to **either spray, spray and back-roll or simply roll.**

- Includes:
- LX-70 In-Line Gun.
 - 90 cm (3') Extruded Pole.
 - Swivel Head Assembly.
 - 23 cm (9") Spray Roller Head Assembly.
 - 23 cm (9") Pressure Roller Head Assembly.

Product No. 310-110



Pole included in kit

Roller Head Replacement Covers



Spray Roller Replacement Covers		
Size	Nap Thickness	Product No.
22.86 cm (9")	1.2 cm (1/2")	311-050-9
22.86 cm (9")	1.9 cm (3/4")	311-075-9
22.86 cm (9")	3.1 cm (1 1/4")	311-125-9

Inner Feed Pressure Roller Replacement Covers		
Size	Nap Thickness	Product No.
22.86 cm (9")	.95 cm (3/8")	312-037-9
22.86 cm (9")	1.2 cm (1/2")	312-050-9
22.86 cm (9")	1.9 cm (3/4")	312-075-9
22.86 cm (9")	3.1 cm (1 1/4")	312-125-9

Hose and Whips

ConvertoKits, Gauge Kits, Swivels

High Quality Airless Hose

- Urethane cover is bonded to an inner nylon braid making it highly flexible and kink resistant.
- Conductive tube design for proper grounding.
- Durable abrasion-resistant urethane cover resists wear.

Part No.	I.D.	Length		Maximum Working Pressure		End Connection
		Meters	Feet	MPa	psi	
316-513	.63 cm (1/4")	7.6	25	22.8	3300	1/4" NPSM (FBE) Swivel
316-505	.63 cm (1/4")	15.2	50	22.8	3300	1/4" NPSM (FBE) Swivel
250-114*	.63 cm (1/4")	15.2	50	31	4500	1/4" NPSM (FBE) Swivel
250-614*	.63 cm (1/4")	7.6	25	51	7400	1/4" NPSM (FBE) Swivel
690-375-50	.95 cm (3/8")	15.2	50	22.8	3300	1/4" NPSM (FBE) Swivel
250-538*	.95 cm (3/8")	15.2	50	37	5400	3/8" NPSM (FBE) Swivel
225-112*	1.27 cm (1/2")	7.6	25	20.7	3000	1/2" NPSM (FBE) Swivel
250-112*	1.27 cm (1/2")	15.2	50	20.7	3000	1/2" NPSM (FBE) Swivel
250-512*	1.27 cm (1/2")	15.2	50	35.2	5100	1/2" NPSM (FBE) Swivel
250-638*	.95 cm (3/8")	15.2	50	51	7400	3/8" NPSM (FBE) Swivel

Airless Fluid Hose Whips

Part No.	I.D.	Length		Maximum Working Pressure		End Connection
		Meters	Feet	MPa	psi	
550-240	.48 cm (3/16")	0.9	3	22.8	3300	.63 cm (1/4") NPSM (F/M) Swivel
316-506	.48 cm (3/16")	1.5	5	22.8	3300	.63 cm (1/4") NPSM (F/M) Swivel
550-222	.48 cm (3/16")	2.7	9	22.8	3300	.63 cm (1/4") NPSM (F/M) Swivel
550-221	.48 cm (3/16")	4.5	15	22.8	3300	.63 cm (1/4") NPSM (F/M) Swivel
203-514*	.63 cm (1/4")	0.9	3	31	4500	.63 cm (1/4") NPSM (FBE) Swivel
550-227	.63 cm (1/4")	1.8	6	22.8	3300	.63 cm (1/4") NPSM (F/M) Swivel
316-533*	.63 cm (1/4")	1.8	6	22.8	3300	.63 cm (1/4") NPSM (FBE) Swivel

* Textile Braid - Spring guards at both ends
 NPT - National Pipe Tapered Thread
 NPSM - National Pipe Straight Mechanical Thread

FBE - Female Both Ends
 MBE - Male Both Ends
 F/M - 1 Female / 1 Male Connection

ConvertoKits

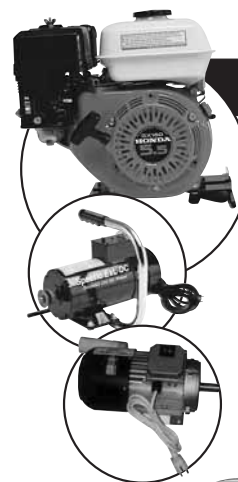

- Petrol engines feature low oil warning system to help prevent engine failure.
- Extended life ExL-DC electric motors are totally enclosed fan cooled (TEFC) with thermal protection.
- Rated at 10,000 hour life.

3 hp DC electric 230 v	PowrTwin 5500, 6900 ^{XLT} , 8900 ^{XLT} and 12,000 ^{XLT}	506-251
3 hp DC electric 230 v	PowrTwin 3500 and 4900 ^{XLT}	506-252
4 hp Honda petrol	PowrTwin 4900 ^{XLT}	506-112
2 hp DC electric 110 v	PowrTwin 4900 ^{XLT}	506-217
5.5hp Honda petrol	PowrTwin 6900 ^{XLT} DI	506-275
2 hp ExL-DC electric 110 v	PowrTwin 6900 ^{XLT}	506-211
6.5 hp Honda petrol	PowrTwin 8900 ^{XLT}	506-278
2 hp ExL-DC electric 110 v	PowrTwin 8900 ^{XLT}	506-276
9 hp Honda petrol	PowrTwin 12,000 ^{XLT} DI	506-277
2 hp ExL-DC electric 110 v	PowrTwin 12,000 ^{XLT}	506-207
2 hp ExL-DC electric 110 v	All GHD and XLT DI models	506-279

High Pressure Fluid Gauge Kit



Includes: 34.5 MPa (5000 psi) high pressure fluid gauge attached to a T-Fitting.

Product No. 730-420 - .95 x .95 cm (3/8 x 3/8)
 Product No. 730-397 - .63 x .95 cm (1/4 x 3/8)
 Fluid Gauge Only 730-394

High Pressure Swivels

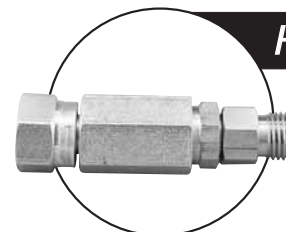

Gun-To-Hose/Hose-To-Pump
 .63 cm (1/4") NPS (F) x .63 cm (1/4") NPS (M)
Product No. 500-428

- Pressure rated at 34.5 MPa (5000 psi).
- Reduce the chance of hose kinks, extend hose life.
- Reduce effort when coiling and uncoiling hose.
- Less arm fatigue when attached to gun.
- Patented ball bearing design.

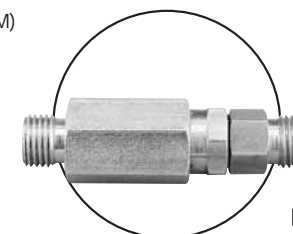

Hose-To-Hose
 .63 cm (1/4") NPS(M) x .63 cm (1/4") NPS(M)
Product No. 500-424

Fittings

Filters, Packing Kits, Lubricants



90° Street Elbows

DESCRIPTION	PART NO.
3/8" NPT(F) X 3/8" NPT(M)	818-002
1/2" NPT(F) X 1/2" NPT(M)	818-003
3/4" NPT(F) X 3/4" NPT(M)	818-010



Reducer Bushings

DESCRIPTION	PART NO.
3/8" NPT(M) X 1/8" NPT(F)	929-060
3/8" NPT(M) X 1/4" NPT(F)	817-001
1/2" NPT(M) X 1/4" NPT(F)	929-061
1/2" NPT(M) X 3/8" NPT(F)	541-009
3/4" NPT(M) X 1/4" NPT(F)	929-062
1" NPT(M) X 3/4" NPT(F)	929-076
1 1/4" NPT(M) X 3/4" NPT(F)	929-078
1 1/4" NPT(M) X 1" NPT(F)	929-077



Hose To Hose Couplings

DESCRIPTION	PART NO.
1/4" NPS(M) X 1/4" NPS(M)	490-012
1/4" NPS(M) X 3/8" NPS(M)	490-016
3/8" NPS(M) X 3/8" NPS(M)	490-014
1/2" NPS(M) X 1/2" NPS(M)	449-621

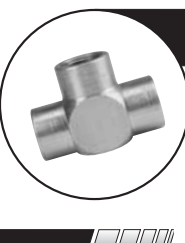

Pipe Tees

DESCRIPTION	PART NO.
1/4" NPT (F)	970-023
3/8" NPT (F)	817-002
1/2" NPT (F)	817-003
3/4" NPT (F)	817-004

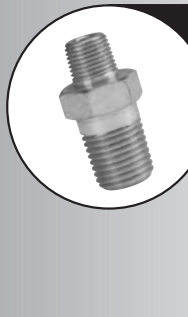

Manifold To Manifold Couplings

DESCRIPTION	PART NO.
1/4" NPT(M) X 1/4" NPT(M)	490-002
1/4" NPT(M) X 3/8" NPT(M)	490-006
3/8" NPT(M) X 3/8" NPT(M)	814-004
3/8" NPT(M) X 1/2" NPT(M)	814-005
1/2" NPT(M) X 1/2" NPT(M)	814-006
1/2" NPT(M) X 3/4" NPT(M)	101-201
3/4" NPT(M) X 3/4" NPT(M)	814-007

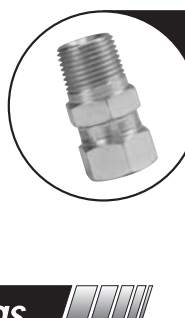

Swivel Union

DESCRIPTION	PART NO.
1/4" NPS(F) X 1/4" NPT(M)	490-005
3/8" NPS(F) X 1/4" NPT(M)	490-042
1/4" NPS(F) X 3/8" NPT(M)	490-032
3/8" NPS(F) X 3/8" NPT(M)	490-043
1/2" NPS(F) X 1/2" NPT(M)	200-555
3/4" NPS(F) X 3/4" NPT(M)	138-037
1" NPS(F) X 1" NPT(M)	200-556

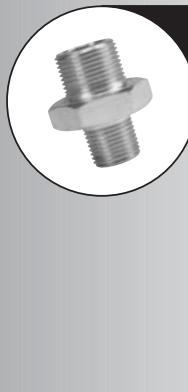

Manifold To Hose Couplings

DESCRIPTION	PART NO.
1/8" NPT(M) X 1/4" NPS(M)	490-001
1/8" NPT(M) X 3/8" NPS(M)	654-016
1/4" NPT(M) X 1/4" NPS(M)	227-006
1/4" NPT(M) X 3/8" NPS(M)	804-555
1/4" NPT(M) X 1/2" NPS(M)	814-003
3/8" NPT(M) X 1/4" NPS(M)	812-003
3/8" NPT(M) X 3/8" NPS(M)	808-555
3/8" NPT(M) X 1/2" NPS(M)	815-005
1/2" NPT(M) X 1/2" NPS(M)	228-002
3/4" NPT(M) X 1/2" NPS(M)	814-555



Pipe Plugs

DESCRIPTION	PART NO.
1/8" NPT (M)	227-030
1/4" NPT (M)	227-027
3/8" NPT (M)	227-033
1/2" NPT (M)	210-023
3/4" NPT (M)	210-038



Pump Manifold Filters

Mesh	Product No.
Coarse-30 mesh	730-067-30
Medium-60 mesh	730-067
Fine-100 mesh	730-067-10

Mesh	Product No.
Coarse-30 mesh	761-042
Medium-60 mesh	761-043
Fine-100 mesh	761-041



Piston Lube

- Specially formulated to prevent materials from adhering to the piston rod.
- Suitable for use with most airless piston pumps.

Size	Product No.
237 mL (8 oz) bottle	314-480
118 mL (4 oz) bottle	314-481



Coolflo™

- Hydraulic Fluid for PowrTwin and Hydra sprayers.

Size	Product No.
.95 L (1 qt) bottle	430-362
3.79 L (1 gal)	430-361
.95 L (1 qt) bottle (case of 12)	430-363



LS-10 Liquid Shield Plus

- Cleans and protects your spray system against rust and corrosion.
- Extends the life of your pump.
- Now with anti-freeze protection.

Size	Product No.
.95 L (1 qt) bottle	314-482
118 mL (4 oz) bottle	314-483

Mesh	Product No.
Coarse-5 mesh	920-001
*Medium-50 mesh	920-004
Fine-100 mesh	920-005

*Note: Standard with sprayer, excludes ball. Ball Check sold separately 920-103

Mesh	Product No.
Mastic-0 Mesh	930-004
Coarse-5 mesh	930-005
*Medium-50 mesh	930-006
Fine-100 mesh	930-007

*Note: Standard with sprayer, includes ball.

Air Care

- Specially formulated to prevent corrosion in air motors.
- Suitable for use with most air driven sprayers.

Size	Product No.
.95 L (1 qt) bottle	311-101

Grease

- Specially designed for gear boxes.
- 414 mL (14 oz) can.

Product No. 314-171

Repacking Kit Chart

Sprayer	Repacking Kit
704-113	330
704-586	440ix, 640ix
702-130	440E, 447EX, 660EX, PM690
730-401	440HP, 440XC, 440i, 447HPX, 3205E, 3305E, 3405, 550XC, 640i, 660HPX, 660XC, 690HPG, 690GXC, PL3100, 3100SL
762-175	E15, G40, 1100HPX, 1100XC, 3211E, 3311XC
761-175	E20, G55, 1200HPG, 1200GXC, 3212G, 3312GXC, PM5500, PL3500
800-450	740i, ix
800-273	840i, ix and 1140i, ix
107-051	PT3500, PT4500, PT4900, PL4000, PL5000
143-050	PT5500, 5500GHD, PT6900, PL6000, PL6900
144-050	PT8900, PT10000, PT12000, PL8900
185-050	HYDRA PRO IV, BOSS
315-050	HYDRA M 2000
245-050	HYDRA M 4000

Filters, Inlet Screens

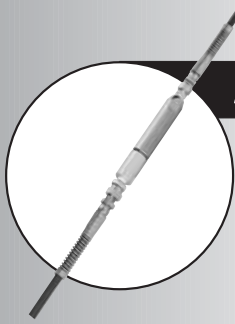

In-Line Filter

Designed for added filtration or when using a gun without a filter, this In-Line filter attaches easily between standard airless hoses.

Product No. 550-223

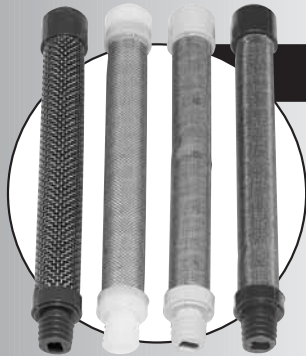

Gun and Pump Filters

Reverse thread design prevents filter from unscrewing when handle is removed for cleaning and replacement. Packaged two per pack.

Threaded Filters

Filters	Product No.
Coarse (Green)	500-200-03
Medium (White)	500-200-06
Fine (Yellow)	500-200-10
Extra Fine (Red)	500-200-15

For use with LX-80*, LX-80 Platinum, and Manifold Filter for 330, 340 and 440.

Unthreaded Filters

Filters	Product No.
Coarse (Green)	550-484
Medium (White)	550-483
Fine (Yellow)	550-485
Extra Fine (Red)	550-486

For use with LX-70, S-3 and S-7.

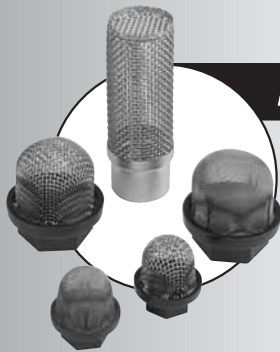

Inlet Screens

Never operate your siphon or direct immersion airless pump without this in place. Also known as a "rock catcher", this product serves as a filtering screen and prevents any debris from entering the fluid section that can cause damage and expensive repairs.

Titan Inlet Screens (Small)

	Product No.
30 mesh (Fine)	700-900
10 mesh (Coarse)	700-805

Titan Inlet Screens (Large)

	Product No.
30 mesh (Fine)	710-191
10 mesh (Coarse)	710-046

Speeflo Inlet Screens

	Product No.
4900, 6900, 8900, 12000GH and HydraPro IV	103-627
All GHD Units	710-046

Modular Gun Manifolds

Gun Manifold Assemblies

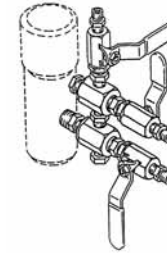

3-GUN MANIFOLD ASSEMBLY

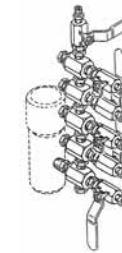

6-GUN MANIFOLD ASSEMBLY

1/4" Multiple Gun Manifold Assemblies*

Part Number	Part Number	975-212 2-GUN .63 cm (1/4)"	975-213 3-GUN .63 cm (1/4)"	975-214 4-GUN .63 cm (1/4)"
975-111	1-GUN ADD ON .63 cm (1/4)"	1	1	1
975-200	ADD-A-GUN Kit .63 cm (1/4)"	1	1	3

*Hose Connection is .63 cm (1/4)" NPSM(M)

3/8" Multiple Gun Manifold Assemblies*

Part Number	Part Number	975-312 2-GUN .95 cm (3/8)"	975-313 3-GUN .95 cm (3/8)"	975-314 4-GUN .95 cm (3/8)"
975-311	1-GUN ADD ON .95 cm (3/8)"	1	1	1
975-300	ADD-A-GUN Kit .95 cm (3/8)"	1	2	3

*Hose Connection is .95 cm (3/8)" NPSM(M)

Gun Add On Kits

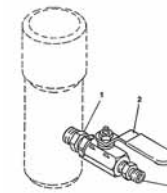

1-GUN ADD-ON KIT



ADD-A-GUN KIT

Gun Manifold Assemblies

Item No.	Part No.	Description	975-111 1-GUN ADD-ON .63 cm (1/4)"	975-311 1-GUN ADD-ON .95 cm (3/8)"	975-200 ADD-A-GUN KIT .63 cm (1/4)"	975-300 ADD-A-GUN KIT .95 cm (3/8)"
1	814-002	Nipple, Hex	1		1	
1a	814-004	Nipple, Hex		1		1
2	940-553	Valve, Ball	1		1	
2a	941-555	Valve, Ball		1		1
3	227-006	Nipple, Hex	1		1	
3a	808-555	Nipple, Hex		1		1
4	227-033	Plug, Pipe			1	1
5	970-100	Block, Manifold			1	1
6	814-004	Nipple, Hex			1	1

Pro-Finish HVLP Gun

Pro-Finish HVLP Gun

- For use with the Titan Pro-Finish Series and Impulse Series Portable Turbine Systems.
- Extra large air passages provide state-of-the-art performance and atomization.
- Large fluid passages offer unrestricted flow of the coating being sprayed, including latexes and multi-colored coatings.
- Stainless steel fluid passages allow you to spray a wide range of coatings.
- Fan pattern adjustable from 6.35 mm to 406 mm (1/4" to 16").
- Large, user friendly control knobs.
- Comes complete with #0 air cap, .051 needle/nozzle set, needle tip removal tool and tip cleaning brush.

Product No. 773-390 Gun with .95 L (Quart) Cup
 Product No. 773-300 Gun Only
 Product No. 770-878 Viscosity Cup

Indexing air cap allows you to quickly change fan patterns from horizontal to vertical to circular.

Turbulence chamber inside air cap breaks down coating particle size for better atomization.

Exclusive design assures perfect centering of air cap on nozzle.

Spare air intake nipple.

Exclusive flex tube feature keeps the siphon tube in the coating at all times.

Now you can spray laterally without starving fluid to the nozzle.

Large, user-friendly control knobs.

Comfortable, well-balanced design reduces hand fatigue and increases production.

Exclusive location of air supply to paint cup provides superior atomization of a wide range of today's finishing coatings.

Round Air Cap Brush Product No. 773-135
 Cup Brush Product No. 770-118
 HVLP Nozzle Tool Product No. 773-134

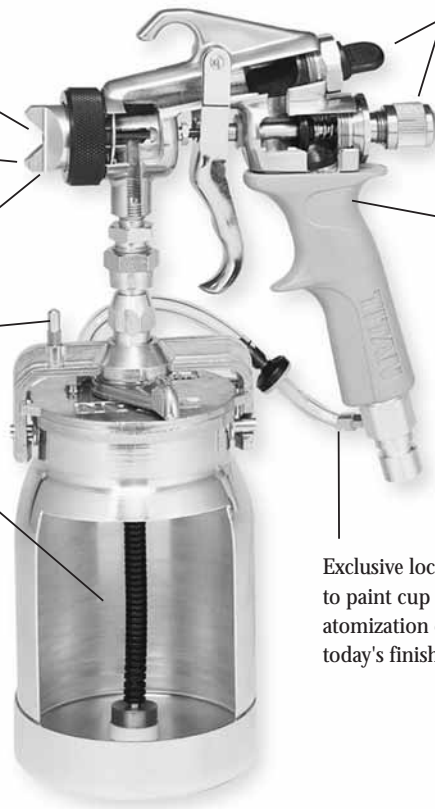

Pro-Finish Gun Accessories

Pro-Finish Needle/Nozzle Set



For use with 773 Series Gun with Gray Handle.

Product No.	Size
773-151	.7 mm (.029")
773-152	1.1 mm (.043")
773-153	1.3 mm (.051")
773-154	1.9 mm (.073")
773-155	3 mm (.118")

Pro-Finish Air Cap



For use with 773 Series Gun with Gray Handle.

Product No.	Size
773-156	0
773-157	1
773-158	2
773-159	3
773-160	4

Pro-Finish Atomizing Kit

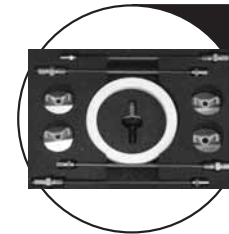

This set comes complete with the full range of needles, nozzles and air caps. It also includes an extra one-way valve and cup lid gaskets. This kit is compatible with all gray handle Pro-Finish spray guns.

- Includes: 4 Air Caps - #1, #2, #3 and #4
 4 Needle/Nozzle Sets -.029, .043, .073 and .118
 3 Quart Cup lid gaskets
 1 One-way valve

Product No. 773-165 Molded to fit directly into TS unit storage area.

Pro-Finish Needle/Nozzle and Air Cap Recommendation Chart*

Silver air caps are for use with gray handle Pro-Finish Gun.

Material	Viscosity	Needle/Nozzle	Air Cap**
Acrylic Lacquers, Stains, Dyes	Thin	.7 mm (.029")	#3
Waterborne Clears, Epoxy, Polyurethanes, Automotive Base Coat, Acrylic Urethanes, Enamels	Medium	1.1mm (.043")	#2
Finish Grade Latexes, Full Bodied Stains, Alkyd Enamels, Waterborne Enamels	Medium Thick	Standard with gun 1.3 mm (.051")	#0 Standard with Gun #0, #1
Finish Grade Latexes, Alkyd Wall Paints	Thick	1.9 mm (.073")	#1, #0
High Body, Multi-Colored	Thick-Heavy	3 mm (.118")	#4

* Note: Most coatings listed must be reduced to a spray consistency to ensure proper atomization. Consult coating manufacturer's instructions for proper reduction recommendations.

** The sizes listed are recommendations only. A test should be performed to determine which works best with the coating being sprayed.

Pro-Finish Accessories

Pro-Finish Fluid Hoses

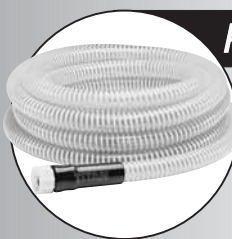

Pro-Finish Air Hose

- 19 mm (3/4") High Volume Hose.

Product No.	Length
770-455	3 m (10 ft)
770-447	6 m (20 ft)
770-456	7.6 m (25 ft)
770-457	9 m (30 ft)



.95 L (Quart) Cup

- .95 L (Quart) Cup (complete with lid).
Product No. 773-140

- .95 L (Quart) Cup (without lid).
Product No. 773-560

- .95 L (Quart) Cup Lid. Product No. 773-131
- Flex Tube- 3 pack. Product No. 773-206

- Inlet Filter. Product No. 773-173
- Inlet Barb Weight. Product No. 773-137

- Flex Tube. Product No. 773-172
- Solvent Tube. Product No. 773-945



9.5 Lt. (2.5 Gal) Disposable Liner

Product No. 770-535



Regulator Complete

- Complete with gauge and fittings.

Product No. 770-567A

Gauge Only
Product No. 770-544



Siphon Filters

- .95 L (Quart) Cup Filter.
Product No. 770-536 (1 each)

- Pressure Pot Filter.
Product No. 770-537 (1 each)



.95 L (Quart) Cup Strainer

- 12 Per Pack.

Product No. 770-119



.95 L (Quart) Cup Lid One-Way Valve

Product No. 770-715
(Also replaces product No. 770-557)

- Clear plastic tube (not shown).
Product No. 770-241 (2 required)

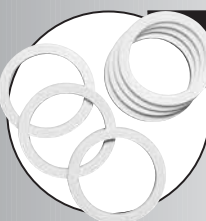

.95 L (Quart) Cup Lid Gaskets

- Solvent resistant.

Product No. 770-584 (1 each)



61 cm (2 Ft.) Flexible Whip

Product No. 770-438



Pro-Finish Fluid Hose

- .95 cm (3/8") fluid hose with female fittings on both ends.

Product No.	Length
770-465	3 m (10 ft.)
770-466	6 m (20 ft.)
773-765	9 m (30 ft.)



Quick Disconnect

Attaches to any length air hose or whip.
For use with the Titan HVLP Pro-Finish Gun.
Product No. 770-240



TSP System

Enables you to easily convert your Titan Pro-Finish system to a portable pressure fed system. Large flat mounting platform easily accepts other manufacturers portable turbines for conversion to a portable pressure fed system. Weighs only 32 kg (70 lbs).

- Includes:
- Cart with handle and hose rack
 - Pneumatic tires
 - 9.4 L (2.5 gal) pressure pot with and regulator
 - .25 (1/4) hp compressor
 - 6.1 m (20 ft.) fluid hose

Pro-Finish TSP System - 230 v Product No. 773-619 -CE
Pro-Finish TSP System - 110 v Product No. 773-618

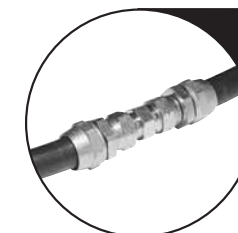

Fluid Hose Connector

- .95 cm (3/8") NPS (M) x .95 cm (3/8") NPS (M)
Product No. 490-014



Turbine Replacement Filters

Pro-Finish 400 -2 required
Product No. 772-730

Pro-Finish TS40/TS50 -2 pack
Product No. 773-655

Pro-Finish 300/350 -3 pack
Product No. 770-460

*TITAN is your complete source
for paint sprayers and accessories.*

Imported by:

Distributed by:

International Sales

Titan Tool, Inc.

Tel: 1.201.405.7480

Fax: 1.201.405.7449

Website: www.titantool.com

Distribution Center

Titan Tool, Inc.

1770 Fernbrook Lane

Plymouth, MN 55447 USA



*Global Leader in Paint
Spray Technology*



VISIT US ON THE WEB AT: www.titantool.com

© 2008 Titan Tool Inc. Titan and Speeflo are registered trademarks of Titan Tool Inc.
JB50352 SL 40003 / 06-2008