



Air & Fluid Hose

Components for Superior Spray Finishing

Bulk Air and Fluid Hose Reels • Hose Assemblies • Tubing • Connections • Valves • Fittings



Performance. Durability. Precision Engineering.

Bringing you *The Best of Both Brands™* - Binks & DeVilbiss.



Table of Contents

About Binks2

Features and Benefits3

Hose Construction and Hose Types4

How to Select the Right Hose5

Pressure Drop6

Chemical Resistance Chart7

Premium Spray Finishing Air Hose8

ErgoFlex™ Air Hose9

Fluidall™ Fluid Hose10

Specialized Hose Assemblies . . .11

Tubing15

Reusable Connections16

Accessories18

Adapters, Nipples & Swivels19

Bringing the Best to You

As pioneers in the development of industrial spray finishing, Binks and DeVilbiss have set the standards for finishing technology for over 100 years. Business partners since 1998, Binks and DeVilbiss have now combined their air and fluid hose expertise to bring you *The Best of Both Brands*. Just what does that mean for you? The highest quality performance possible. Superior durability that withstands the harshest of today's coatings. Precision engineering to keep your finishing operation running smoothly. And, the combined resources of the industry's best technical and customer support teams. *The Best of Both Brands*. - Taking quality to the next level.

New Binks Air & Fluid Hose

New and improved Binks brand (low pressure) air and fluid hose is a winning combination of the best components of both Binks and DeVilbiss air and fluid hose. Precision engineered for maximum performance and durability, Binks air and fluid hose is your best choice for assuring that your equipment receives air and fluids at the specified pressures and volume levels.

Premium Air Hose

- Smooth cover for easy cleaning
- Increased flexibility
- High working pressure (250 psi)
- Uses standard or existing fittings
- Available in 300 foot or 500 foot continuous reels



Ergoflex™ Air Hose

- Improved ergonomic design for maximum maneuverability and flexibility
- Working pressure of 125 psi
- Improved temperature resistance
- Uses standard or existing fittings
- Available 500 foot continuous reels



Fluidall™ Fluid Hose

- Working pressures 500 - 750 psi depending on hose I.D.
- Good chemical resistance - non-corrosive
- Nylon tube for excellent chemical resistance
- Excellent flexibility
- Uses standard or existing fittings
- Smooth cover for easy cleaning
- Available in both 300 foot and 500 foot continuous reels



Exceeding Industry Standards

Features and Benefits

Product Selection

- Air and fluid hose for a wide variety of applications.
- Static wire hose for uses requiring application grounding.
- Fluid hose for resinous materials with or without catalysts.
- Teflon, nylon and polyethylene tubing.
- Reusable and quick disconnect connections.
- Air and fluid hose fittings.
- Ball valves and air-adjusting valves.
- Component construction in a variety of materials.

Performance Benefits

- Better Tolerances – Consistent hose I.D. ensures constant fluid and air delivery and a uniform fit for connections. Binks hose maintains I.D. tolerances better than rubber hose industry standards.
- Maximum Flexibility – Greater flexibility means easier handling. Binks unique braid design provides maximum flexibility under pressure.
- Oil Resistance – The rubber compound used in most Binks hose covers and tubes, EPDM and nylon, is unaffected by compressor oils. Binks hose covers will not become gummy at the hose connections and weaken the assembly.
- Abrasion Resistance – Tough enough to resist tearing and abrasion from dirt, grit and cement floors but pliable and flexible enough for use with all hand held tools.
- Kink Resistance – Binks braid reinforcement design offers maximum kink resistance and flexibility unobtainable with spiral wound, woven, or knit reinforcements.
- Value-priced – given its value-added performance characteristics and superior quality, Binks hose is reasonably priced – especially when compared to less carefully designed and manufactured hose.

Hydrostatic Pressure Tests

Hydrostatic pressure tests are classified as follows:

1. Destructive Type
 - a. Burst test
 - b. Hold test

Destructive Tests

Destructive tests are conducted on short specimens of hose, normally 18 inches (441mm) to 36 inches (882mm) in length and, as the name implies, the hose is destroyed in the performance of the test.

- a. Burst pressure is recorded as the pressure at which actual rupture of a hose occurs.
 - b. A hold test, when required, is a means of determining whether weakness will develop under a given pressure for a specified period of time.
2. Nondestructive Type
 - a. Proof pressure test
 - b. Change in length test (elongation or contraction)
 - c. Change in outside diameter or circumference test
 - d. Warp test
 - e. Rise test
 - f. Twist test
 - g. Kink test
 - h. Volumetric expansion



Nondestructive Tests

Nondestructive tests are conducted on a full length of a hose or hose assembly and are for the purpose of eliminating hose with defects which cannot be seen by visual examination or in order to determine certain characteristics of the hose while it is under internal pressure.

- a. A proof pressure test is normally applied to hose for a specified period of time. On new hose, the proof pressure is usually 50% of the minimum specified burst. The regulation of these pressures is extremely important so that no deteriorating stresses will be applied, thus weakening a normal hose.
- b. With some type of hose, it is useful to know how a hose will act under pressure. All change in length tests, except when performed on wire braid or wire spiraled hose, are made with original length measurements taken under a pressure of 10 psi (0.069 Mpa). The specified pressure, which is normally the proof pressure, is applied and immediate measurement of the characteristics desired are taken and recorded.

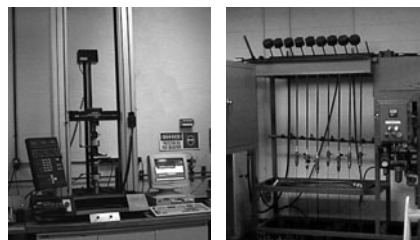
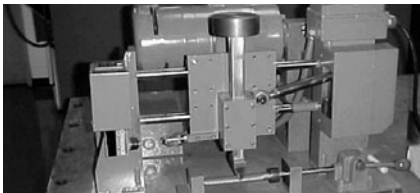

Hose Construction & Hose Types

Basic Hose Construction

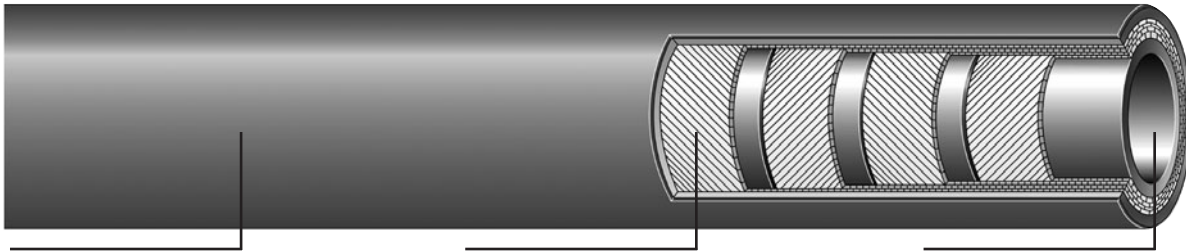

The **Cover** is the outermost or most visible area of the hose. It serves as a protective covering against wear, abrasion, cuts, weather, and the normal wear and tear of normal service.

The **Body or Carcass** reinforcement is the supporting structure of the hose. It ranges from simple to complex combinations and consists of cord, yarn, fabric, wire, or any combination of these.

The **Tube or Lining** is the innermost element of a hose and is compounded to provide resistance to the material being carried. The wide range of rubber compounds available allows a hose to be built to withstand abrasive materials, chemicals, oil, and a variety of other materials.

Hose Types

Type 1

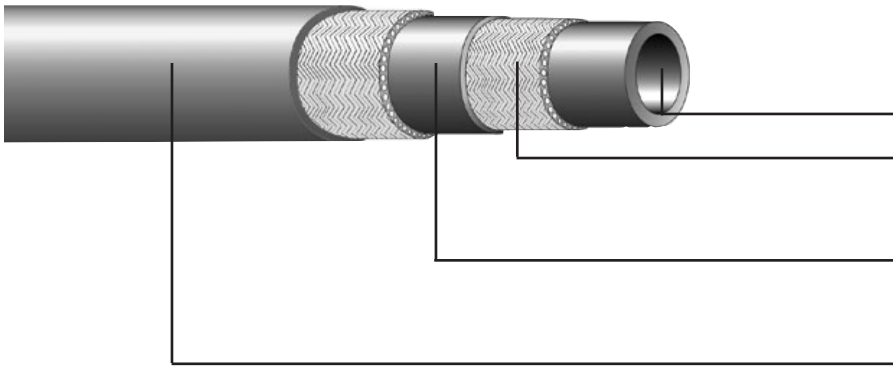

Type 1: Vertical Braided Hose

Entire hose length cured in one operation. Flexible. High resistance to kinking. Smooth cover. Excellent tensile strength.

- A. Extruded seamless tube.
- B. Seamless reinforcing braids of synthetic textile wire or other materials.
- C. Rubber layers between braids to establish a positive bond between braids when vulcanized.
- D. Extruded, seamless cover.

Type 2

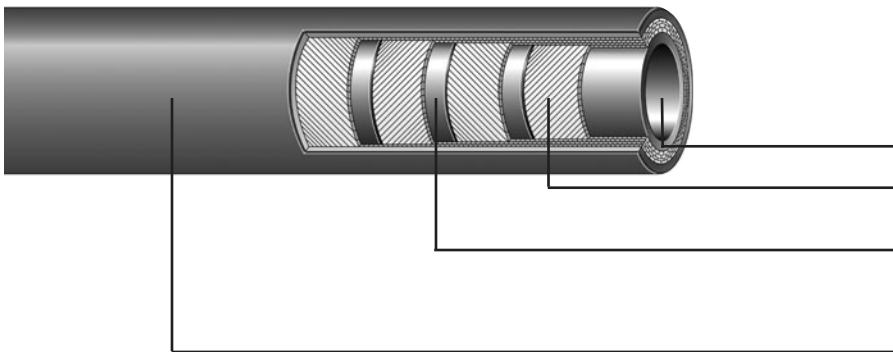

Type 2: Spiral Hose

Textile or wire cord reinforcement to ensure maximum dimensional stability. Extremely flexible. Smooth bore. Uniform tube. High strength.

- A. Extruded or calendered tube.
- B. Reinforced with synthetic textile wire or other materials.
- C. Rubber layers between reinforcement plies to establish a positive bond.
- D. Cover.

How to Select the Right Hose

Plan Ahead to Ensure Optimal Performance

To ensure maximum performance and service:

- Select the right hose for the job
- Fit the hose correctly
- Use the hose in the proper environment

Keep these basic factors in mind when choosing any hose:

- Maximum pressure (including any possible surge or back pressure)
- CFM of air or volume of fluid required
- Working length of hose
- Hose I.D. (inside diameter)
- Hose O.D. (outside diameter)
- Precise composition of material to be conveyed (air, water, lacquer, enamel, etc.)
- Maximum temperature of materials conveyed
- External conditions such as abrasion, climate, heat, contamination, flexing, kinking, bending, etc.
- Couplings to be used, types of threads, material compatibility
- Types of attachment methods

Conditions Affecting Hose Performance

Overall Considerations

- External abuse, kinking, bending, high end pull, crushing, and abrasion
- Exposure to higher-than-rated working pressures
- Exposure to surge pressures
- Exposure to higher-than-rated temperatures
- Misapplication or exposure to corrosive liquids or gases beyond the manufacturer's recommended range

External Conditions

- Do not place hoses where they will be run over by equipment
- Avoid subjecting hoses to high end pull
- Do not bend below recommended minimum bend radius to avoid kinking and pressure resistance reduction
- Provide additional support to large diameter hose as needed

Hose & System Pressures

- Any application can have several pressures depending on pressure sources and pressure surges due to operator and/or mechanical components. Be sure to choose the right hose for the application.
- Choose hose with slightly higher working pressure ratings if equipment has a tendency toward pressure surges.
- All hoses have pre-determined maximum pressure and application points and still provide optimal performance. To ensure satisfactory life, be sure to follow the manufacturer's recommendations carefully.

Misapplication

- Follow all application information for selection, installation, care, maintenance, and storage
- Failure to follow recommended application criteria can result in the hose's failure and damage to property or workers

Chemical and Temperature

- Do not exceed allowable temperature ranges
- High temperatures can degrade rubber stocks and decrease service life
- Select fittings (brass, steel, stainless steel) for compatibility

Oil Resistance Classifications

The effects of oil on rubber depends on a number of factors that include the type of rubber compound, the composition of the oil, the temperature, and the time of exposure. Rubber compounds can be classified as to their degree of oil resistance based on their physical properties after exposure to a standard test fluid. In this RMA classification, the rubber samples are immersed in IRM 903 oil at 100°C for 70 hours. As a guide to the user of hose in contact with oil, the oil resistance classes and a corresponding description are listed below.

EPDM physical properties after exposure to oil

	Volume Change Maximum	Tensile Strength Retained
Class A (High oil resistance)	+25%	80%
Class B (Medium/High oil resistance)	+65%	50%
Class C (Medium oil resistance)	+100%	40%

Common Terms

(F) Female Thread
 (FBE) Female Both Ends
 (M) Male Thread
 (MBE) Male Both Ends
 CFM Cubic Feet Per Minute
 ID Inside Diameter
 JIC Joint Industrial Council
 NPS National Pipe Straight
 NPT National Pipe Tapered
 OD Outside Diameter
 PSI Pounds Per Square Inch
 SS Stainless Steel
 SW Swivel
 WP Maximum Working Pressure
 MPA ? x 145 = P.S.I.

Metric Conversion

1 cm. = 0.3937 in.
 1 bar = 14.5 psi.
 1 liter = 0.264 gal. (U.S.)
 1 kg. = 2.205 lb.
 1 meter = 3.28 ft.
 1 millimeter = 0.03937 inches

Understanding Pressure Drop

Pressure Drop Basics

Understanding pressure drop requires a basic knowledge of cfm (cubic feet per minute) and psi (pounds per square inch). CFM refers to the given volume of air that flows past a given point in one minute. PSI is the amount of force pushing the cubic foot of air through the hose or tool.

The amount of air that a tool consumes will remain constant for a given set of conditions. Pressure will always drop when the tool is turned on and when the air begins to flow through the hose. In addition, pressure drop will vary in relation to any adjustment made on the tool.

The same pressure loss principles apply when moving fluid through a hose. Be sure to consider pressure loss when choosing fluid hose and fittings.

Pressure Drop Points

Losses in pressure (psi) are dependent on the variables of hose length, hose diameter, volume (cfm), and the number and design of quick disconnects. To minimize the effects of pressure drop and the resulting lack of volume, consider the following:

- Frictional resistance between the fluid and the walls of the hose
- Internal resistance (shear) – fluid moves faster through the center of the hose and slower against the walls
- Change in direction of air or fluid through the system
- Volume at any given time as determined by back pressure
- The number of system connections, adapters, nipples, valves, filters, and air and fluid controls
- Hose I.D. – use the minimum I.D. necessary for each application
- Hose length – pressure drop is proportional to hose length
- Surface of the hose's inner tube – a rough surface can increase pressure drop up to 50%

Pressure Drop Chart

Hose Sizes: 1/4" to 1" I.D.

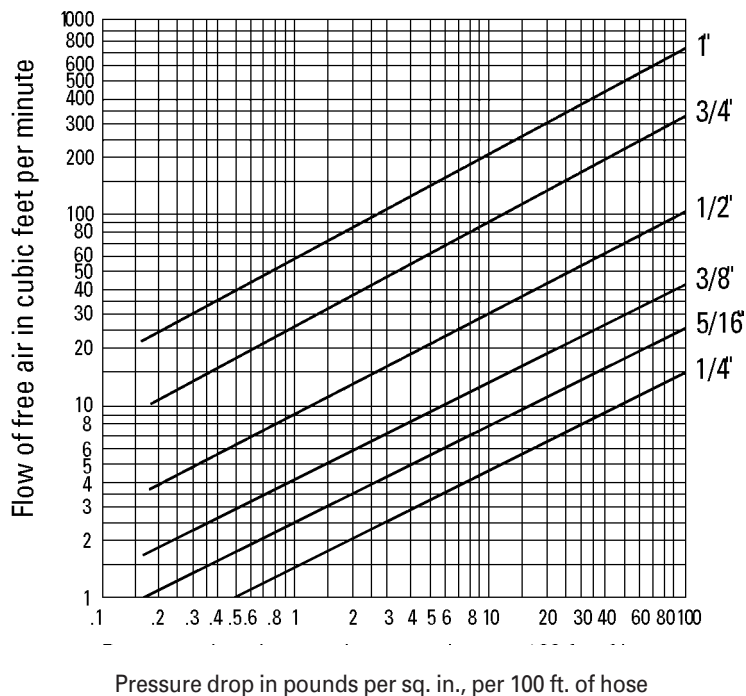

To determine pressure drops for hose lengths other than 100':

$$(\text{Pressure Drop Chart Figure}) \times \frac{(\text{Ft. of Hose})}{100} = \text{Pressure drop for hose used}$$

Technical Data

This chart is for approximating and should only serve as a guide in sizing air hose. Pressure drop is directly proportional to hose lengths. That means that if hose length doubles, for example, pressure drop doubles.

Example:

- 100' x 1/2" I.D. hose at 40 cfm has a pressure loss of 17 1/2 psi.
- 200' x 1/2" I.D. will lose 35 psi.
- 50' x 1/2" I.D. will lose between 8 to 9 psi.

Technical Data

Binks hose is rated for continuous operation at the rated working pressures shown in the selection chart that follows. In addition, Binks hose is designed to withstand maximum vibration and flexing when properly installed.



Choose hose with a slightly higher working pressure rating if your equipment has a tendency to pressure surge to help provide a sufficient safety factor in most applications. The chart below is a guideline to help select the best hose for your application requirements. Consider pressure,

temperature, exposure, etc., when selecting hose to help ensure maximum performance. A word about connections . . . be sure to choose the fitting connection type and construction material (brass, steel, stainless steel) for maximum compatibility with your application requirements.

Chemical Resistance Chart

TYPES OF SOLVENTS, THINNERS, CATALYSTS	FLUIDALL™ FLUID HOSE PAGE 10 & 12	HIGH PRESSURE AIRLESS PAGE 13 & 14	NYLON TUBING PAGE 15	POLYETHYLENE TUBING PAGE 15
Drying Oils, Alkyds (Mineral Spirits)(Naphtha)	●■	●■	●■	●
Phenolic Varnishes, Epoxy Esters Coal Tars, 1 Pkg. Urethanes (Naphtha – Toluene Blend)	●■	●■	●■	●
Chlorinated Rubber, Chlor. Rub. Zinc Rich Silicones, "Hypalon" (Toluene), (Xylene)	●■	●■	●■	○
Phenolics, Epoxies, Epoxy Zinc Rich Vinyl Alkyds (Toluene – MEK Blend)	●■	●■	●■	○
Vinyls, Vinyl-Acrylics, Polyesters, Polyester Zinc Rich, (MEK), (MIBK)	●■	●■	●■	○
Lacquers, 2 Pkg. Urethanes High Gloss Enamels (Ketone – Ester Blend)	●■	●■	●■	○
PV Acetate, Polyacrylics Latex, Zinc Silicates, (Water Based)	●	●	●	●
Water-Based	●	●	●	-
Aromatic, Solvent Based	-	●	-	-
Chlorinated, Solvent Based	●	●	●	-

Key to Chart:

Material at Room Temperature: ● Continuous Service ○ Intermittent Service

Heated Material: ■ Continuous Service

BINKS AIR HOSE CROSS REFERENCE CHART:

AIR HOSE	CURRENT PART NUMBER	CANCELLED PART NUMBER
1/4" I.D.	71-10000	71-130, 71-135, H-1957, H-1900
5/16" I.D.	71-11000	71-131, 71-136, H-1921, H-1901
3/8" I.D.	71-12000	71-132, 71-137, H-1958
1/2" I.D.	71-13000	71-133, H-1961
3/4" I.D.	71-14000	71-134
Air Hose with Static Wire		
5/16" I.D.	71-20000	71-151, H-1641-1
3/8" I.D.	71-21000	H-1995
Ergo-Flex Air Hose		
3/8" I.D.	71-31000	H-3670

BINKS FLUID HOSE CROSS REFERENCE CHART:

FLUID HOSE	CURRENT PART NO..	CANCELLED PART NO.
1/4" I.D.	71-280	H-1975-1
5/16" I.D.	NONE	H-1976-1
3/8" I.D.	71-282	H-1973-1
1/2" I.D.	71-283	H-1974-1
3/4" I.D.	71-284	NONE
1" I.D.	71-285	NONE

Premium Spray Finishing Air Hose

Smooth Cover

Recommended Use

Premium spray finishing air hose. Class B oil resistance. Designed for all finishing operations as well as rugged industrial applications, especially applications requiring lubricants in the airline supply or where oil and grease are present in the environment. Excellent for use with water and water-based materials. Temperature range from -40°F to +200° F (max).

Tube

EPDM Class B oil resistance.

Reinforcement

High tensile strength spiral reinforcement. Specially designed for maximum flexibility (under pressure) and maximum coupling retention.

Cover

EPDM, red, smooth. Abrasion resistant. Oil Resistance.

Connections

Three-piece, plated brass, reusable.

I.D. Sizes

1/4", 5/16", 3/8", 1/2" and 3/4"
Smooth Cover.

BINKS AIR HOSE CROSS REFERENCE CHART:

Air Hose	Current Part Number	Cancelled Part Number
1/4" I.D.	71-10000	71-130, 71-135 H-1957, H-1900
5/16" I.D.	71-11000	71-131, 71-136 H-1921, H-1901
3/8" I.D.	71-12000	71-132, 71-137 H-1958
1/2" I.D.	71-13000	71-133, H-1961
3/4" I.D.	71-14000	71-134

Additional information regarding connections are on pages 16 and 17.



Reusable Connections

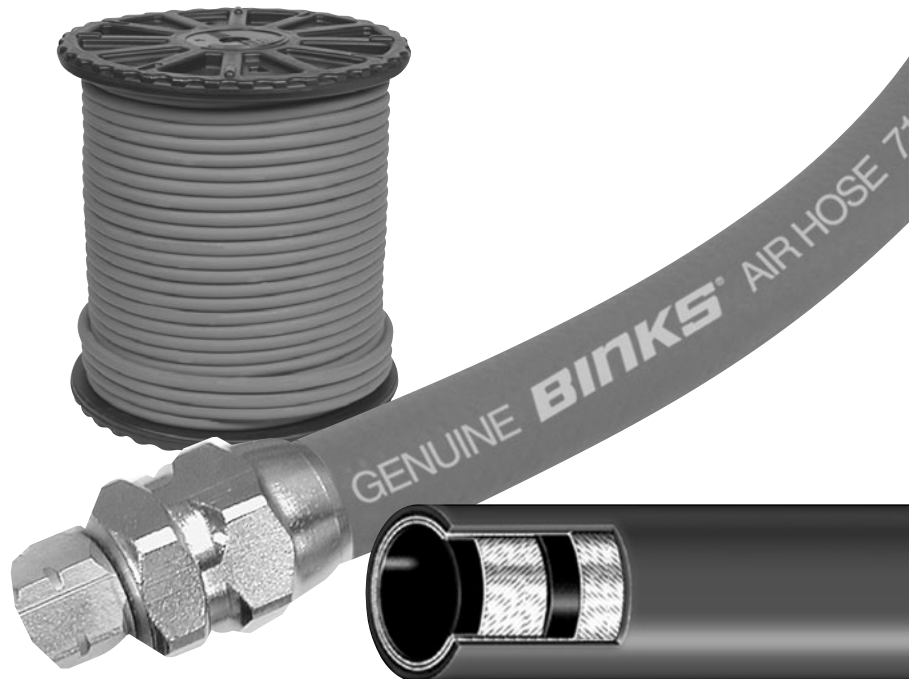

Bulk Hose Chart – Smooth Cover

SIZES AVAILABLE I.D.	O.D.	BULK HOSE NUMBER	MAXIMUM WORKING PRESSURE (PSI)	BEND RADIUS	STD. REEL LENGTH IN FT. 1 PIECE REEL	APPROX. SHIPPING WEIGHT BASED ON FEET PER REEL	HOSE WEIGHT PER 100 FEET
1/4"	1/2"	71-10000	250	2 3/4"	500	50 lbs.	10 lbs.
5/16"	5/8"	71-11000	250	3"	500	87 lbs.	16.2 lbs.
3/8"	11/16"	71-12000	250	3 1/2"	500	96 lbs.	18 lbs.
1/2"	7/8"	71-13000	250	5"	300	86 lbs.	26.8 lbs.
3/4"	1 1/8"	71-14000	250	6"	300	112 lbs.	35 lbs.

Premium Hose Assemblies and Connections

SIZES I.D.	LENGTH OF HOSE	HOSE ASSEMBLY PART NO.	BULK HOSE NUMBER	CONNECTION THREAD SIZE	TYPE OF CONNECTION	CONNECTION PART NUMBER
1/4"	5 ft.	71-1101	71-10000	1/4" NPS (f)	three piece reusable	72-1303
1/4"	25 ft.	71-1105	71-10000	1/4" NPS (f)	three piece reusable	72-1303
1/4"	50 ft.	71-1106	71-10000	1/4" NPS (f)	three piece reusable	72-1303
5/16"	5 ft.	71-1201	71-11000	1/4" NPS (f)	three piece reusable	72-1317
5/16"	15 ft.	71-1203	71-11000	1/4" NPS (f)	three piece reusable	72-1317
5/16"	25 ft.	71-1205	71-11000	1/4" NPS (f)	three piece reusable	72-1317
5/16"	50 ft.	71-1206	71-11000	1/4" NPS (f)	three piece reusable	72-1317
3/8"	25 ft.	71-1355	71-12000	1/4" NPS (f)	three piece reusable	72-1325
3/8"	50 ft.	71-1356	71-12000	1/4" NPS (f)	three piece reusable	72-1325

Lightweight ErgoFlex™ Hose

Smooth Cover

Compare Binks' new 3/8" I.D. ErgoFlex™ HVLV Hose with any other hose and see for yourself. There's a difference you can see. A difference you can feel. Here's what makes Binks ErgoFlex HVLV Hose the better hose:

- 40% lighter weight than standard 3/8" I.D. air hose & fittings
- More flexible than 1/4", 5/16" and 3/8" I.D. air hose
- Durable, solvent resistant outer covering
- 125 psi working pressure
- 600 psi burst pressure
- No outside clamp or locking device required
- Conductive core, dissipates static build-up at air tool
- Temperature range from – 40°F to +200°F (Max)



Recommended Use

Binks ErgoFlex™ HVLV Hose is suitable for use with all kinds of air-operated equipment, including those requiring lubricant in the air line, or in environments where oil and grease are present.

Tube

Black EPDM Class B – Oil Resistance.

Reinforcement

Synthetic yarn – Spiral reinforcement.

Cover

Tan EPDM, smooth, Class C – Oil resistance.

I.D. Size

3/8" (9.53 mm)

O.D. Size

.646"

Connection

One-piece, plated brass, reusable. (72-2008)

Bulk Hose Chart – Smooth Cover

SIZES AVAILABLE I.D. O.D.	BULK HOSE Number	MAXIMUM WORKING PRESSURE (PSI)	BEND RADIUS	STD. REEL LENGTH IN FT. 1 PIECE REELS	APPROX. SHIPPING WEIGHT BASED ON. FEET PER REEL	HOSE WEIGHT PER 100 FEET
3/8" .646"	71-31000	125	3 1/2"	500	70 lbs.	12.8 lbs.

BINKS ErgoFlex™ AIR HOSE CROSS REFERENCE CHART:

AIR HOSE	CURRENT PART NUMBER	CANCELLED PART NUMBER
Ergo-Flex Air Hose 3/8" I.D.	71-31000	H-3670

ErgoFlex™ Hose Assemblies and Connections

SIZES I.D.	LENGTH OF HOSE	HOSE ASSEMBLY PART NO.	BULK HOSE NUMBER	CONNECTION THREAD SIZE	TYPE OF CONNECTION	CONNECTION PART NUMBER
3/8"	25 ft.	71-31101	71-31000	1/4" NPS (f)	three piece reusable	72-2008
3/8"	50 ft.	71-31102	71-31000	1/4" NPS (f)	three piece reusable	72-2008
3/8"	6 ft.	71-31103	71-31000	1/4" NPS (f)	three piece reusable	72-2008



Fluidall™ Fluid Hose

Nylon Lined, Maximum Versatility

Recommended Use

Premium, versatile fluid hose, for finishing operations plus a wide range of fluid applications. Fluidall™ is ideal for resins and solvents contained in latices, epoxies, urethanes, alkyds, primers, acrylics, polyesters, silicones, bitumastic coatings, oil and water based paints, lacquers, alcohol and latex coatings. Temperature range from 0° F to +190°F (max).

Tube

Nylon.

Reinforcement

High tensile synthetic braid. Specially designed for maximum flexibility (under pressure) and maximum coupling retention.

Cover

Black, synthetic, smooth rubber. Class B – Oil Resistance.

Connections

Three-piece, plated brass, reusable.

I.D. Sizes

1/4", 3/8", 1/2", 3/4" and 1".



Bulk Hose Chart-Smooth Cover

SIZES AVAILABLE		BULK HOSE NUMBER	MAXIMUM WORKING PRESSURE (PSI)	BEND RADIUS	STD. REEL LENGTH IN FT. 1 PIECE REEL	APPROX. SHIPPING WEIGHT BASED ON FEET PER REEL	HOSE WEIGHT PER 100 FEET
I.D.	O.D.						
1/4"	1/2"	71-280	500	3"	500	43 lbs.	8 lbs.
3/8"	11/16"	71-282	500	3 1/2"	500	83 lbs.	15 lbs.
1/2"	7/8"	71-283	750	5"	300	74 lbs.	22 lbs.
3/4"	1 3/16"	71-284	750	8"	300	118 lbs.	36 lbs.
1"	1 1/2"	71-285	750	12"	300	168 lbs.	53 lbs.

Hose Assemblies and Connections

BINKS FLUID HOSE CROSS REFERENCE CHART

Fluid Hose	Current Part No.	Cancelled Part No.
1/4" I.D.	71-280	H-1975-1
5/16" I.D.	NONE	H-1976-1
3/8" I.D.	71-282	H-1973-1
1/2" I.D.	71-283	H-1974-1
3/4" I.D.	71-284	NONE
1" I.D.	71-285	NONE

SIZES I.D.	LENGTH OF HOSE	HOSE ASSEMBLY PART NO.	BULK HOSE NUMBER	CONNECTION THREAD SIZE	TYPE OF CONNECTION	CONNECTION PART NUMBER
1/4"	5 ft.	71-3380	71-280	3/8" NPS (f)	three piece reusable	72-1306
1/4"	25 ft.	71-3383	71-280	3/8" NPS (f)	three piece reusable	72-1306
1/4"	35 ft.	71-3390	71-280	3/8" NPS (f)	three piece reusable	72-1306
1/4"	50 ft.	71-3384	71-280	3/8" NPS (f)	three piece reusable	72-1306
3/8"	5 ft.	71-3300	71-282	3/8" NPS (f)	three piece reusable	72-1328
3/8"	25 ft.	71-3303	71-282	3/8" NPS (f)	three piece reusable	72-1328
3/8"	50 ft.	71-3304	71-282	3/8" NPS (f)	three piece reusable	72-1328
1/2"	5 ft.	71-3400	71-283	1/2" NPS (f)	three piece reusable	72-1334
1/2"	25 ft.	71-3403	71-283	1/2" NPS (f)	three piece reusable	72-1334
1/2"	50 ft.	71-3404	71-283	1/2" NPS (f)	three piece reusable	72-1334
1"	5 ft.	71-3360	71-285	1" NPS (f)	three piece reusable	72-1936
1"	10 ft.	71-3361	71-285	1" NPS (f)	three piece reusable	72-1936
1"	8 ft.	71-3367	71-285	1" NPS (f)	three piece reusable	72-1936

Additional information regarding connections are on pages 16 and 17.

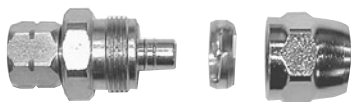

Reusable Connections

Specialized Hose Assemblies

Air Hose Grounded with Static Wire

Recommended Use

Premium finishing air hose. Oil resistance, rating Class B. Designed for all finishing operations as well as rugged industrial applications. Static wire between tube and cover prevents build-up of static electricity. Commonly used with atomizing spray guns, electrostatic spray guns and equipment that requires grounding for safety purposes. Temperature range from -40° F to +200° F.

Tube

EPDM. Class B – Oil Resistance.

Reinforcement

High tensile strength synthetic spiral reinforcement. Specially designed for maximum flexibility (under pressure) and maximum coupling retention.

Cover

EPDM red, smooth, abrasion resistance. – Oil Resistant

Connections

Three-piece, plated brass, reusable should be used.

I.D. Sizes

5/16" I.D. & 3/8" I.D.



Bulk Hose Chart-Smooth Cover

SIZE AVAILABLE I.D. O.D.	BULK HOSE NUMBER	MAXIMUM WORKING PRESSURE (PSI)	BEND RADIUS	STD. REEL LENGTH IN FT. 1 PIECE REELS	APPROX. SHIPPING WEIGHT BASED ON FEET PER REEL	HOSE WEIGHT PER 100 FEET
5/16" .618"	71-20000	250	3"	500	87 lbs.	17.4 lbs.
3/8" .701"	71-21000	250	3.5"	500	96 lbs.	19.2 lbs.

Recommended hose connection 72-1317-1/4" NPS(f), 72-1325-1/4" NPS(f)

Hose Assembly and Connection

SIZE I.D.	LENGTH OF HOSE	HOSE ASSEMBLY PART NO.	BULK HOSE NUMBER	CONNECTION THREAD SIZE	TYPE OF CONNECTION	CONNECTION PART NUMBER
5/16"	25 ft.	71-2803	71-20000	1/4" NPS (f)	three piece reusable	72-1317
5/16"	50 ft.	71-2804	71-20000	1/4" NPS (f)	three piece reusable	72-1317
5/16"	35 ft.	71-2810	71-20000	1/4" NPS (f)	three piece reusable	72-1317

Additional information regarding connections are on pages 16 and 17.

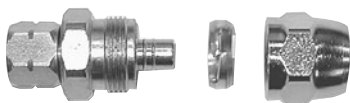

Reusable Connections

BINKS AIR HOSE CROSS REFERENCE CHART:

AIR HOSE	CURRENT PART NUMBER	CANCELLED PART NUMBER
Air Hose with Static Wire		
5/16" I.D.	71-20000	71-151, H-1641-1
3/8" I.D.	71-21000	H-1995

Specialized Fluidall™ Hose Assemblies

Assembled Fluid Hose -Nylon Lined with Stainless Steel Connections

Recommended Use

Fluidall™ fluid hose, for finishing operations plus a wide range of fluid applications. Temperature range -0°F to +190°F. Check recommended use for the stainless steel hose connections used on Fluidall™ hose assemblies to prevent corrosion-contamination, an inherent problem with waterborne coatings.

Tube

Nylon.

Reinforcement

High tensile synthetic braid. Specially designed for maximum flexibility (under pressure) and maximum coupling retention.

Cover

Black, synthetic, smooth, rubber. Class B – Oil Resistance.

Connections

Three-piece, stainless steel, reusable. Additional information regarding connections are on pages 16 and 17.

I.D. Sizes

1/4".



Hose Assemblies and Connections

SIZES I.D.	LENGTH OF HOSE	HOSE		CONNECTION THREAD SIZE	TYPE OF CONNECTION	CONNECTION PART NUMBER
		ASSEMBLY PART NO.	BULK HOSE NUMBER			
1/4"	25 ft.	71-3663	71-280	3/8" NPS (f)SS	three piece reusable	72-2143

Catalyst Hose Assemblies

Assembled Fluid Hose -Nylon Lined with Stainless Steel Connections

Recommended Use

For acid and peroxidized catalyst and other aqueous (water) solutions. Also recommended for use as a light weight, low pressure air hose. May be used for buffing compounds and concrete resurfacing materials.

Tube

EVA

Reinforcement

Single open braid, reyon/nylon

Cover

EVA - blue

Connections

Reuseable, stainless steel tailpiece and swivel, aluminum nut.

I.D. Sizes

1/8", 5/16", 3/8", 3/16"

SIZES I.D.	LENGTH OF HOSE	CATALYST HOSE			CONNECTION THREAD SIZE
		ASSEMBLY PART NO.	BULK HOSE NUMBER	CONNECTION	
1/8" I.D.	18 ft	102-3025 ●	71-201	1/4 NPS(f)	
1/8" I.D.	25 ft	102-3028 ●	71-201	1/4 NPS(f)	
1/8" I.D.	50 ft	102-3030 ●	71-201	1/4 NPS(f)	
5/16" I.D.	15 ft	71-2732 ●	71-508	1/4 NPS(f)	
5/16" I.D.	25 ft	71-2734 ●	71-508	1/4 NPS(f)	
5/16" I.D.	50 ft	71-2735 ●	71-508	1/4 NPS(f)	

HIGH PRESSURE CATALYST S.S. BRAID HOSE ASSEMBLIES				
SIZES I.D.	LENGTH OF HOSE	ASSEMBLY PART NO.	BULK HOSE NUMBER	CONNECTION THREAD SIZE
3/16" I.D.	25 ft	107-1434	--	JIC 4(f) SW 7/16-20
3/16" I.D.	50 ft	107-1465	--	JIC 4(f) SW 7/16-20
3/16" I.D.	25 ft	207-12272-1	--	JIC 3(f) SW 3/8-24
3/16" I.D.	50 ft	207-12272-2	--	JIC 3(f) SW 3/8-24
3/16" I.D.	5 ft	207-12272-3	--	JIC 3(f) SW 3/8-24
3/16" I.D.	45 ft	207-12272-4	--	JIC 3(f) SW 3/8-24
3/16" I.D.	35 ft	207-12272-5	--	JIC 3(f) SW 3/8-24

● These assemblies have connections with spring guards

SIZES AVAILABLE I.D.	O.D.	BULK HOSE NUMBER	MAXIMUM WORKING PRESSURE (PSI)	NO. OF BRAIDS	APPROX. SHIPPING WEIGHT BASED ON FEET PER REEL	HOSE WEIGHT PER 100 FEET	CONNECTION THREAD	CONNECTION PART NO.
1/8	5/16	71-201	100	1	16	3.2	1/4NPS(f)	102-3031 SS316 ●
5/16	17/32	71-508	250	1	33.5	6.7	1/4NPS(f)	72-1646 SS416 ●
							3/8NPS(f)	207-10383 SS416 ●
3/8	19/32	71-509	250	1	37.5	7.5	3/8NPS(f)	

● These assemblies have connections with spring guards

Specialized Hose Assemblies

Premium Airless Paint Spray Hose Conductive – No Wire

Recommended Use

High pressure paint spray applications, including electrical airless. Compatible with a wide range of materials, solvents and water based coatings. Designed for the most durable and extended service. Temperature range -40°F to +180°F.

Tube

Nylon – this no-wire hose incorporates a nylon core tube with a conductive polymer surrounding it. Electrical conductivity will remain throughout the hose life.

Reinforcement

High tensile nylon braid reinforcement.

Cover

Polyurethane, white or yellow depending on hose I.D.

Connections

Permanently attached, plated steel with spring guards.

I.D. Sizes

3/16", 1/4", 5/16" and 3/8".

Specifications

I.D.	O.D.	RATED W.P.	BEND RADIUS	LBS./100 FT.
◇3/16"	.425"	3000 PSI	1 1/2"	4.7
◇1/4"	.520"	3000 PSI	1 1/2"	7.9
●5/16"	.588"	3000 PSI	2"	8.2
●3/8"	.730"	3000 PSI	2 1/2"	13.3

● White Jacket Color. ◇ Yellow Jacket Color.

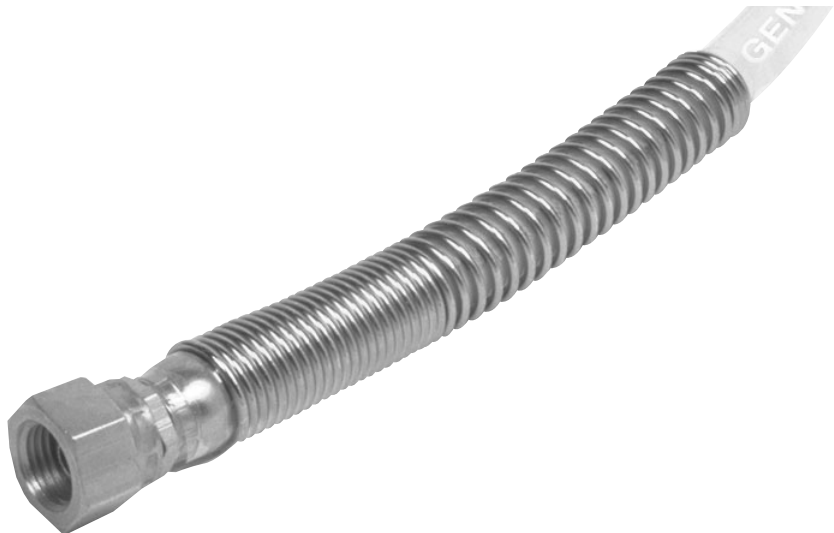

Hose Assemblies and Connections

JACKET COLOR	SIZES I.D.	LENGTH OF HOSE	HOSE ASSEMBLY PART NO.	CONNECTION THREAD SIZE	TYPE OF CONNECTION
◇	3/16"	30 in. whip end	71-8360*	1/4" NPS (f)	permanent
◇	3/16"	5 ft.	71-8085	1/4" NPS (f)	permanent
◇	3/16"	25 ft.	71-8088	1/4" NPS (f)	permanent
◇	3/16"	50 ft.	71-8089	1/4" NPS (f)	permanent
◇	1/4"	5 ft.	71-7708	1/4" NPS (f)	permanent
◇	1/4"	10 ft.	71-7709	1/4" NPS (f)	permanent
◇	1/4"	15 ft.	71-7703	1/4" NPS (f)	permanent
◇	1/4"	25 ft.	71-7704	1/4" NPS (f)	permanent
◇	1/4"	50 ft.	71-7705	1/4" NPS (f)	permanent
●	5/16"	25 ft.	71-7504	1/4" NPS (f)	permanent
●	5/16"	50 ft.	71-7505	1/4" NPS (f)	permanent
●	5/16"	35 ft.	71-7508	1/4" NPS (f)	permanent
●	3/8"	5 ft.	71-8421	3/8" NPS (f)	permanent
●	3/8"	10 ft.	71-8422	3/8" NPS (f)	permanent
●	3/8"	25 ft.	71-8424	3/8" NPS (f)	permanent
●	3/8"	50 ft.	71-8425	3/8" NPS (f)	permanent
●	3/8"	100 ft.	71-8427	3/8" NPS (f)	permanent

* Connection Thread = 1/4" NPS(f) x 1/4" NPT(m) w/30 deg. seat. ● White Jacket Color. ◇ Yellow Jacket Color.
Hose Connector 72-691, 1/4" NPS(m) x 1/4" NPS(m) for connecting hose assemblies together.
Bulk hose not available – assemblies only.

Specialized Hose Assemblies

Contractor Quality Airless Paint Spray Hose Conductive-No wire

Recommended Use

Designed specifically for commercial and industrial painting contractors and heavy work load applications. Excellent flexibility and durability. For use with both solvent and water-based coatings.

Tube

Nylon.

Reinforcement and Cover

Consists of a seamless extruded synthetic braid reinforcement and a pin-pricked polyurethane cover. The innermost braid layer is chemically bonded to the innertube and the outer layer is chemically bonded to the cover. A static drain element consisting of flexible electrically conductive plastic tape is located between the braid layers. Cover-black. Operating temperature from 0°F to +200°F.

Connections

Permanently attached, plated steel with spring guards.

I.D. Sizes

1/4".

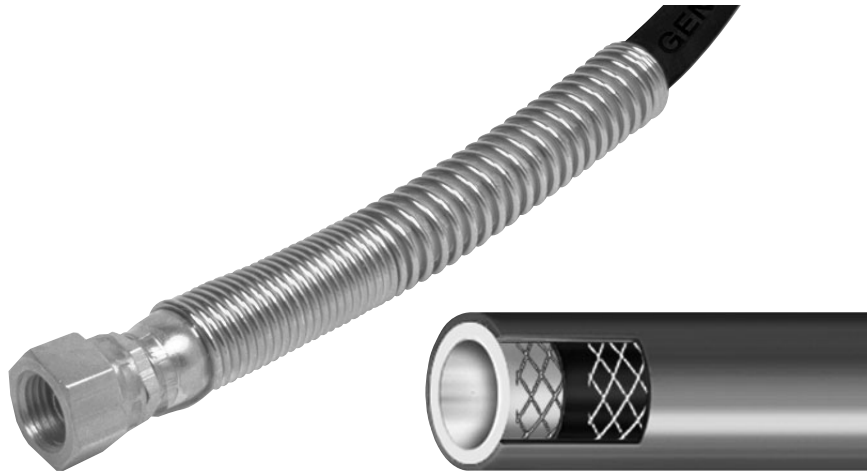

Hose Assemblies and Connections

SIZES I.D.	LENGTH OF HOSE	HOSE ASSEMBLY PART NO.	CONNECTION THREAD SIZE	TYPE OF CONNECTION
1/4"	25 ft.	71-3530	1/4" NPS (f)	permanent
1/4"	50 ft.	71-3531	1/4" NPS (f)	permanent

Working pressure 3,300 PSI.

Hose connector 72-691, Plated Steel, 1/49 NPS(m) x 1/49 NPS(m) for connecting hose assemblies together.

Medium Pressure Paint Spray Hose Conductive-No Wire

Recommended Use

Raptor 18:1 outfit and other air assist airless applications where working pressures do not exceed 1740 psi.

Tube

Nylon.

Connections

1/4" Permanently attached, stainless steel with spring guards.

Performance

- Low ID to OD ratios, lightweight, ergonomic.
- Resistant to most chemicals, paints and solvents.
- Excellent flexibility with small bend radius

Construction

Nylon tube reinforced with braided polyester yarn. Conductivity is by means of a conductive polymer strip. The blue outer cover is polyurethane and provides excellent abrasion resistance. Operating temperature from -40° F - 212° F.

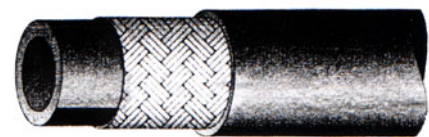

Hose Assemblies and Connections

I.D.	O.D.	LENGTH OF HOSE	HOSE ASSEMBLY PART NO.	THREAD SIZE	TYPE OF CONNECTION
3/16"	.380"	25'	71-4995	1/4" S.S.	permanent
JACKET COLOR	MIN. BEND RADIUS	WORKING PRESSURE	MIN. BURST PRESSURE	WEIGHT LB/FT.	
Blue	1.2"	1740PSI	6960PSI	0.04	

Tubing

Nylon, Polyethylene, Teflon and Reusable Connections

Nylon

Recommended Service

Moderate pressure service for conveying enamels, lacquers, and other fine finishes. (Solvent-resistant nylon tubing.) Also suitable for amine catalysts in foam coating applications. May be used as an air hose (low pressure) in larger sizes shown.

SIZE	BULK TUBING NO.	SOLID THREAD	SOLID PART NO.	CONNECTIONS				HOSE SIZE		RATED WORKING PRESSURE(PSI)		LBS./100 FEET
				SWIVEL THREAD	SWIVEL PART NO.	SWIVEL THREAD	SWIVEL PART NO.	I.D.	O.D.	70°F	150°F	
1/8"	71-226	1/8" NPT(m)	72-1676	1/4" NPS(f)	72-1677	3/8" NPS(f)	72-1805§	1/8"	.225"	475	190	1.25
3/16"	71-230			1/4" NPS(f)	72-1679	3/8" NPS(f)	72-1729	3/16"	.264"	225	190	1.28
				1/4" NPS(f)	72-1747†	3/8" NPS(f)	72-1790§					
				1/4" NPS(f)	72-1789§	3/8" NPS(f)	72-1793‡					
				1/4" NPS(f)	72-1792‡							
1/4"	71-227	1/8" NPT(m)	72-1680	1/4" NPS(f)	72-1681	3/8" NPS(f)	72-1683	1/4"	.350"	225	190	2.18
				1/4" NPS(f)	72-1687†	3/8" NPS(f)	72-1689†					
				1/4" NPS(f)	72-1799§	3/8" NPS(f)	72-1801§					
				1/4" NPS(f)	72-1800‡	3/8" NPS(f)	72-1802‡					
3/8"	71-229			1/4" NPS(f)	72-1811§	3/8" NPS(f)	72-1685	3/8"	.500"	200	140	3.90
						3/8" NPS(f)	72-1812§					

Connections: †Reusable, plated brass, with spring guard
‡Reusable, stainless, with spring guard
§Reusable, stainless swivel nut and tailpiece.

All nylon tubing sold in bulk only – 500 Ft.
Flexible nylon tubing, translucent, no reinforcement.

Polyethylene

Recommended Service

Low pressure air and fluid service. Suitable for conveying water-based paints and catalyst, and for polyester, lacquer and fine finishes.

SIZE	BULK TUBING NO.	CONNECTIONS				HOSE SIZE		RATED W.P., PSI	LBS./100 FEET
		SWIVEL THREAD	SWIVEL PART NO.	SWIVEL THREAD	SWIVEL PART NO.	I.D.	WALL		
1/4"	71-223	1/4" NPS(f)	72-1579	3/8" NPS(f)	72-1581	1/4"	1/16"	100	2.5
		1/4" NPS(f)	72-1583*	3/8" NPS(f)	72-1585*				
				3/8" NPS(f)	72-1839†				

Connections: * Reusable plated brass connection with Spring Guard
† Stainless steel swivel nut and tailpiece

Polyethylene tubing sold per foot – no specific box size
Flexible polyethylene tubing, translucent, no reinforcement

Teflon, Fluid Tubing

SIZE	BULK TUBING NO.	CONNECTIONS			
		SWIVEL THREAD	SWIVEL PART NO.	SWIVEL THREAD	SWIVEL PART NO.
1/8"	71-248	1/4" NPS(f)	72-1944	3/8" NPS(f)	72-1945†
3/16"	71-209	1/4" NPS(f)	72-1577	3/8" NPS(f)	72-1730
1/4"	71-204	1/4" NPS(f)	72-1579	3/8" NPS(f)	72-1581
		1/4" NPS(f)	72-1583*	3/8" NPS(f)	72-1585*
3/8"	71-207			3/8" NPS(f)	72-1685
		1/4" NPS(f)	72-1811†	3/8" NPS(f)	72-1812†

* Furnished with spring guard.
† Stainless Steel swivel nut and tailpiece.
Teflon tubing sold per foot – no specific box size

Specifications

BULK HOSE TUBING NO.	HOSE SIZE		RATED W.P. PSI	LBS./100 FEET
	I.D.	O.D.		
71-248	1/8"	1/4"	140	5
71-209	3/16"	5/16"	140	4.5
71-204	1/4"	3/8"	140	5
71-207	3/8"	1/2"	140	6.5

Reusable Connections

Types and Installations

Types



Type A. Plated Brass

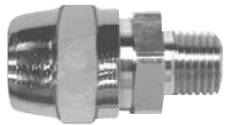

Type B. Plated Brass



Type C. Plated Brass

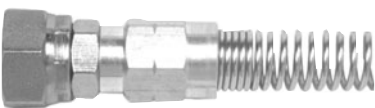

Type D. Plated Brass or SS



Type E. Plated Brass or SS

How to Install Reusable Connections

Compression Sleeve Type

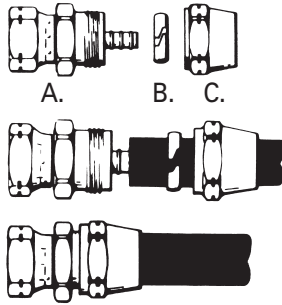

This connection consists of three (3) pieces:
 A. Swivel nut and connector body
 B. Sleeve
 C. Nut

Place a matching double male nipple in a vise and tighten. Screw swivel nut onto fitting and tighten. Remove nut and sleeve from connector. (Replacement sleeves are listed on page 17). Cut hose end square and slide nut over hose approximately 2 inches back from cut. Spread sleeve ring just enough to slide over hose easily. Push hose onto connector body, twisting hose slightly as you push to insure proper seating. Slide sleeve forward and tighten nut until connector body begins to turn. Remove double male nipple – hose and connection are ready to use. Tools required: vise, double male nipple, adjustable wrench, knife.

Punch-Lok Type

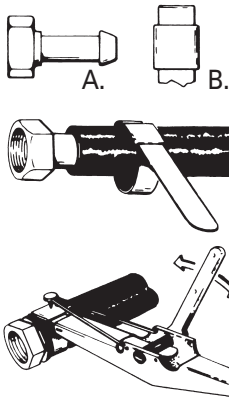

This connection consists of two (2) pieces:
 A. Swivel nut with tailpiece
 B. Punch-Lok strap.

Place a matching double male nipple in a vise and tighten. Screw swivel nut onto fitting and tighten. Cut hose end square and slide Punch-Lok strap onto hose about 3 inches from cut end. Push hose onto connection tailpiece and slide strap forward to approximately 1/4 inch from connector body nut. Insert end of strap into Punch-Lok tool and tighten. Do not overtighten or strap will cut hose. Hold tension on strap and position punch. Strike punch with hammer to lock strap in place. The Punch-Lok tool, when moved up and down will sever excess strap. Remove double male nipple, and hose connection is complete. Tools required: Vise, Punch-Lok tool, double male nipple, adjustable wrench, knife, hammer.

Polyethylene and Nylon Tube Type

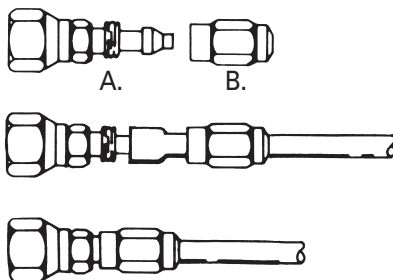

This connection consists of two (2) pieces.
 A. Swivel nut with tailpiece
 B. Nut

Place a matching double male nipple in a vise and tighten. Screw swivel nut onto nipple and tighten. Remove nut from connection and place on hose. Cut hose end square. Push hose onto connection tailpiece and tighten nut on connection. Remove double male nipple.

Reusable Connections

Types and Installations

Air & Fluid Hose Connections

HOSE SIZE I.D.	O.D.	FOR BULK HOSE NO.	CONNECTIONS		
			THREAD	PART NO.	TYPE
1/4"	1/2"	71-10000	1/4" NPS(f)	72-1303	A
			3/8" NPS(f)	72-1306	A
			3/8" NPS(f)SS	72-2143*	A
5/16"	5/8"	71-11000	1/4" NPS(f)	72-1317	A
			1/4" NPT(m)	72-1478	B
			3/8" NPS(f)	72-1320	A
3/8"	1 1/16"	71-12000	1/4" NPS(f)	72-1325	A
			3/8" NPS(f)	72-1328	A
			3/8" NPS(f)SS	72-2146*	A
1/2"	7/8"	71-13000	3/8" NPS(f)	72-1333	A
			1/2" NPS(f)	72-1334	A
			1/2" NPS(f)	72-954†*	C
3/4"	1 3/16"	71-14000	3/4" NPS(f)	72-1336†	C
			3/4" NPS(f)	72-417†	C
			3/4" NPS(f)	72-955†*	C
1"	1 1/2"	71-285	1" NPS(f)	72-418†	C
			1" NPS(f)	72-956†*	C
			1" NPS(f)	72-1936	A

† Punch-Lok connection.
* Stainless Steel tailpiece.

Polyethylene and Teflon Tubing Connections

TUBE SIZE I.D.	O.D.	BULK TUBE NO.	CONNECTIONS		
			THREAD	PART NO.	TYPE
1/8"	1/4"	71-248*	1/4" NPS(f)	72-1944	E
			3/8" NPS(f)	72-1945§	E
3/16"	5/16"	71-209*	1/4" NPS(m)	72-1577	E
			3/8" NPS(f)	72-1730	E
1/4"	3/8"	71-204*	1/4" NPS(f)	72-1579	E
			1/4" NPS(f)	72-1583†	D
			1/4" NPS(f)	72-1968§	E
			1/4" NPS(f)	72-1983§	D
3/8"	1/2"	71-207*	3/8" NPS(f)	72-1581	E
			3/8" NPS(f)	72-1585†	D
			3/8" NPS(f)	72-1839§	E
			3/8" NPS(f)	72-2060§	D
3/8"	1/2"	71-207*	1/4" NPS(f)	72-1811§	E
			3/8" NPS(f)	72-1685	E
			3/8" NPS(f)	72-1812§	E

* Teflon § Stainless Steel; all others plated brass
◇ Polyethylene † Furnished with spring guard

Nylon Hose Connections

FOR BULK HOSE I.D.	NO.	THREAD	CONNECTIONS PART NO.		TYPE
			PLATED BRASS	STAINLESS STEEL	
1/8"	71-226	1/4" NPS(f)	72-1677	—	E
		3/8" NPS(f)	—	72-1805	E
3/16"	71-230	1/4" NPS(f)	72-1679	72-1789	E
		1/4" NPS(f)	72-1747	72-1792	D
		3/8" NPS(f)	72-1729	72-1790	E
		3/8" NPS(f)	—	72-1793	D
		3/8" NPS(f)	—	—	—
1/4"	71-227	1/8" NPT(m)	72-1680	—	E
		1/4" NPS(f)	72-1681	72-1799	E
		1/4" NPS(f)	72-1687	72-1800	D
		3/8" NPS(f)	—	72-2143	E
		3/8" NPS(f)	72-1683	72-1801	E
		3/8" NPS(f)	72-1689	72-1802	D
3/8"	71-229	1/4" NPS(f)	—	72-1811	E
		3/8" NPS(f)	72-1685	72-1812	E
		3/8" NPS(f)	—	72-2146	E

Accessories

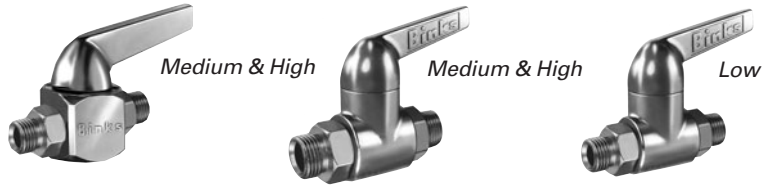

Low & High Pressure Ball Valves

PART NO.	2-WAY 4000 PSI BRASS HIGH PRESSURE
72-13030	1/4 (m)* x 1/4 (m)*
72-14040	3/8 (m)* x 3/8 (m)*
72-14030	3/8 (m)* x 1/4 (m)*

PART NO.	2-WAY 250 PSI DIE CAST (PLATED)
72-83030	1/4 (m)* x 1/4 (m)*
72-84040	3/8 (m)* x 3/8 (m)*
72-81414	1/4 NPT (f) x 1/4 NPT (f)
72-84030	3/8 (m)* x 1/4 (m)*
72-84015	3/8 (m)* x 3/8 NPT (f)

PART NO.	2-WAY 4000 PSI STAINLESS STEEL
172-33535	1/4 (m)* x 1/4 (m)*
172-34545	3/8 (m)* x 3/8 (m)*
172-31414	1/4 NPT (f) x 1/4 NPT (f)

PART NO.	3-WAY 250 PSI BRASS PLATED (1/4 NPT (f) INLETS)
73-81414	1/4 NPT (f) x 1/4 NPT (f)
73-83030	1/4 (m)* x 1/4 (m)*
73-84040	3/8 (m)* x 1/4 (m)*

* Universal (m) thread

72-1823

72-1927*

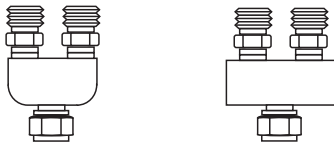

Zinc Diecast
Body



Low Pressure Manifolds

PART NO.	Threads	Swivel Nut
72-1823	(2) 3/8" NPS(m)	3/8" NPS(f)

PART NO.	Threads	Swivel Nut
72-1927*	(2) 1/4" NPS(m)	1/4" NPS(f)

* Plated brass threads, plated steel body and swivel nut

Hose Sets

Part No.	Description
6-438	25' Air & Fluid (5/16" air x 3/8" fluid)
KB-4006	6' Air & Fluid (5/16" air x 1/4" fluid)

Air Valves

PART NO.	TYPE	THREAD
HAV-500	Straight	1/4" NPS(f) 1/4" NPS(m)
73-159	90°	1/4" NPS(f) 1/4" NPS(m)

Hose Sleeve

Part No.	Description
MSVAD-416	100' Poly Hose Sleeve

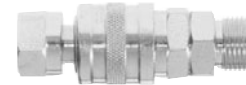

72 Series Quick Disconnect
(Body and Stem Assembly)

Low Pressure Fluid Quick Disconnects

PART NO.	DESCRIPTION	THREAD
72-887	Stem Assembly Only	3/8" NPS (f)
72-885	Body Assembly Only	3/8" NPS (m)
72-888	Body & Stem Assembly	3/8" NPS(m) x 3/8" NPS (f)
72-897	Body & Stem Assembly	3/8" ID Hose x 3/8" NPS (f)
72-896	Body Assembly Only	3/8" ID Hose



Part No. 72-445
(Stem Only)



Part No. 72-2063
(Body Only)

Low Pressure Air Quick Disconnects

PART NO.	DESCRIPTION	THREAD
72-445	Stem Assembly Only	1/4" NPS (f)
72-467	Stem Assembly Only	1/4" NPT (m)
72-2063	Body Assembly Only	1/4" NPS (m)
72-2066	Body Assembly Only	5/16" ID Hose
72-2073	Body Assembly Only	1/4" NPT (f)
72-470	Body & Stem Assembly	1/4" NPS(m) x 1/4" NPT(m)
72-476	Body & Stem Assembly	1/4" NPT (f) x 1/4" NPT (m)
72-2076	Body & Stem Assembly	1/4" NPS (m) x 1/4" NPS (f)

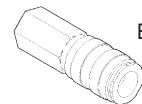

Body



Stem

High Flow Quick Disconnect

PART NO.	TYPE	QD BODY
HC-4699	1/4 NPT(M)	HI-Flow QD Body
HC-4700	1/4 NPT (F)	HI-Flow QD Body

PART NO.	TYPE	QD STEM
HC-1166	1/4 NPT (M)	HI-Flow QD Stem
HC-4419	1/4 NPT (F)	HI-FlowQD Stem

Adapters, Nipples & Swivels

Low Pressure - 250 P.S.I Max.



Adapters (Plated Brass)

PART NO.	MALE THREAD	FEMALE THREAD
73-131	1/4" NPS	1/4" NPS
72-55	1/4" NPS	3/8" NPS
72-54	3/8" NPS	1/4" NPS
73-130	3/8" NPS	3/8" NPS



Double Male Nipples

PART NO.	MALE THREAD	MALE THREAD
71-28*	1/8" NPT	1/4" NPS
57-126	1/8" NPS	1/4" NPS
83-576	1/4" NPT	1/4" NPS
57-13*	1/4" NPT	1/4" NPS
83-1050	1/4" NPS	1/4" NPS
73-50*	3/8" NPS	3/8" NPT
83-1185*	3/8" NPT	3/8" NPT
83-1823	1/2" NPS	1/2" NPT
83-1822*	3/4" NPS	3/4" NPT
72-423*	1" NPT	1" NPS

Brass, * Plated Brass or Electroless Nickel-Plated



90° Connections

PART NO.	THREAD	SWIVEL NUT
73-18	1/4" NPS(m)	3/8" NPS

High Pressure - 4000 P.S.I. Max



Adapters

PART NO.	FEMALE THREAD	MALE THREAD
—	3/8" NPS	1/4" NPS
102-2193	3/8" NPT	1/4" NPS
72-731	3/4" NPT	3/4" NPS
72-1110	—	3/4" NPS



Double Male Nipples

PART NO.	MALE THREAD	MALE THREAD
—	1/8" NPT	1/4" NPS
72-792	1/8" NPT	3/8" NPS
—	1/4" NPS	1/4" NPT
72-690	1/4" NPS	1/4" NPS
72-691	1/4" NPT	3/8" NPS
—	1/4" NPT	3/8" NPS
83-2484	1/4" NPT	3/8" NPT
72-988	—	3/8" NPT
—	3/8" NPS	3/8" NPT
83-2055	3/8" NPS	1/4" NPS
72-1888	3/8" NPS	1/2" NPS
—	3/8" NPT	1/2" NPS
72-798	3/8" NPT	1/2" NPT
—	1/2" NPS	1/2" NPT
72-1932	1/2" NPS	3/4" NPT
—	3/4" NPS	1" NPS
72-1933	—	1" NPS
—	1" NPT	1" NPS
41-1235	—	1" NPS
—	1" NPT	1" NPS
72-1770	—	1" NPS
—	1" NPT	1" NPS
72-1981	—	1" NPS



Swivel Unions and Swivel Adapters

PART NO.	SWIVEL NUT
41-1412	1/4" NPS
83-1935	1/4" NPS
—	3/8" NPS
83-1697	3/8" NPS



90° Connections

PART NO.	THREAD
72-918*	1/4" NPS(f)
—	3/8" NPS(f)
73-24*	3/8" NPS(m)

* With Swivel Nut



Hose or Gun Swivel

PART NO.	TYPE	THREAD
72-780	Straight	1/4" NPS(m)

Plated Steel

**Sales and Service
Through a Nationwide Network of Industrial Distributors**



North American Office

ITW Industrial Finishing
Binks

195 Internationale Blvd.
Glendale Heights, IL 60139
630-237-5000
Fax 630-237-5011
www.binks.com

Customer Service

1-800-992-4657

Technical Support

1-888-992-4657

